

# MOULDING & TRANSPORT

## RAIL COACH

24576

0.823 kg/m

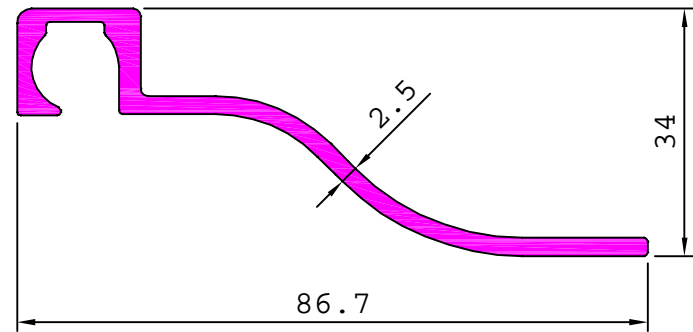

24578

1.031 kg/m

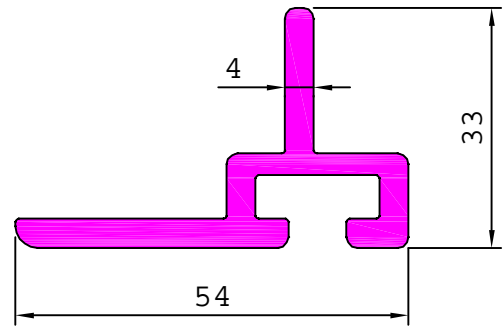

24577

2.626 kg/m

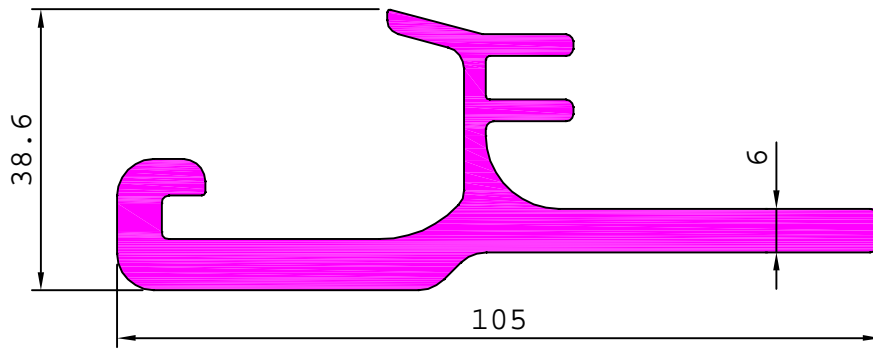

24579

3.016 kg/m

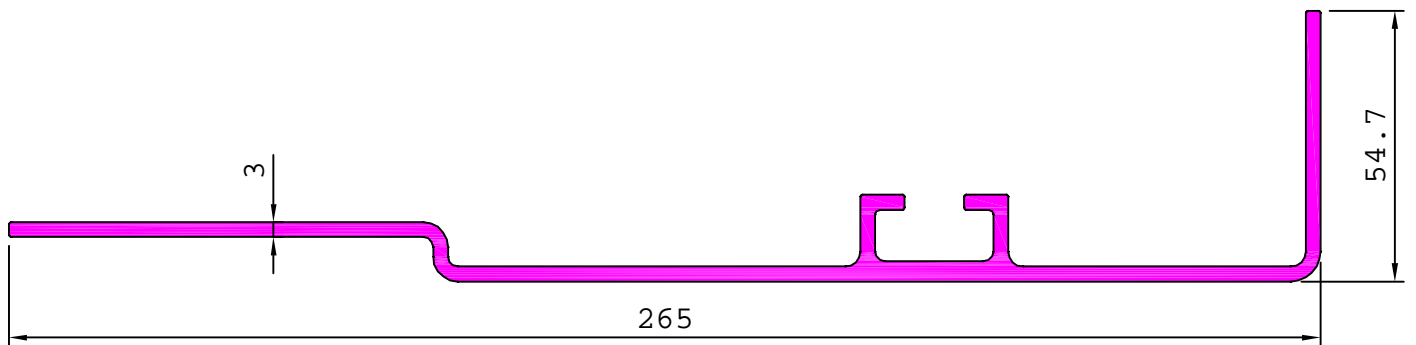

24580

4.938 kg/m

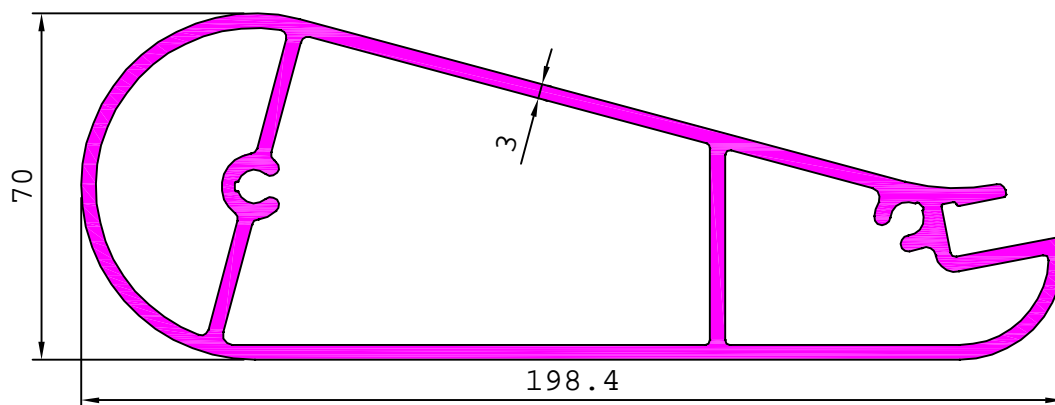

# MOULDING & TRANSPORT

## RAIL COACH

24581

5.589 kg/m

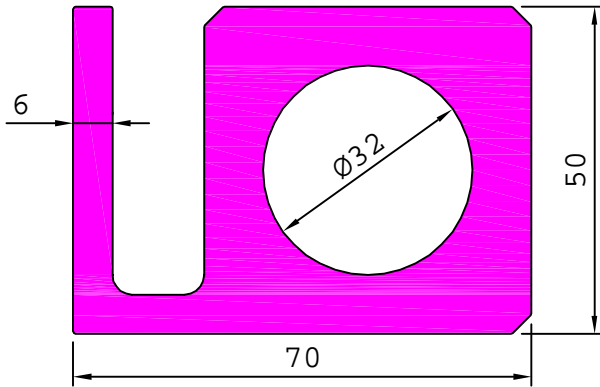

24582

2.439 kg/m

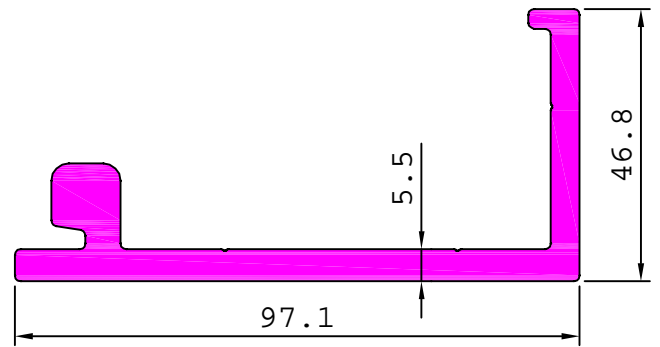

24583

0.804 kg/m

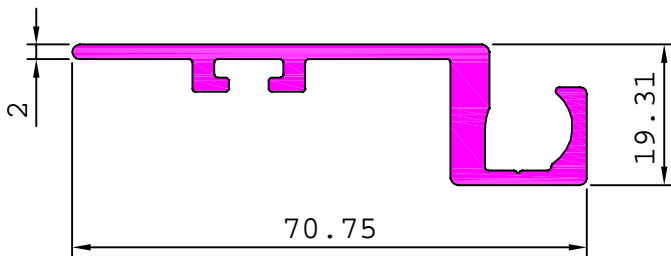

24584

0.875 kg/m

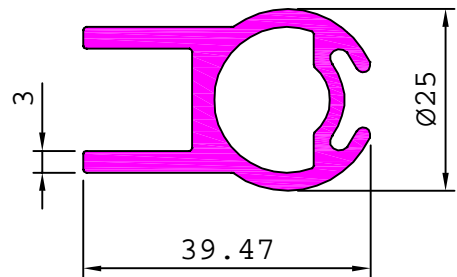

24585

0.828 kg/m

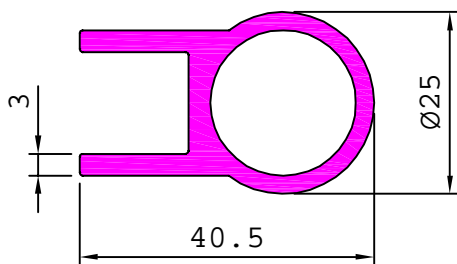

24589

1.025 kg/m

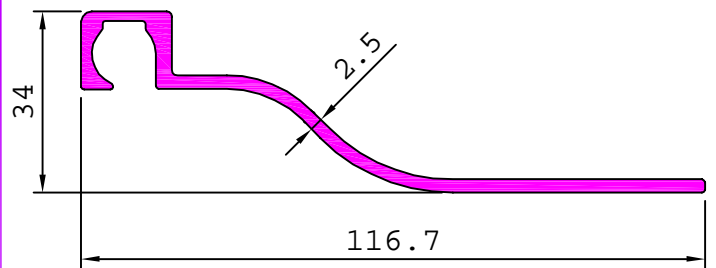

S6499

2.007 kg/m

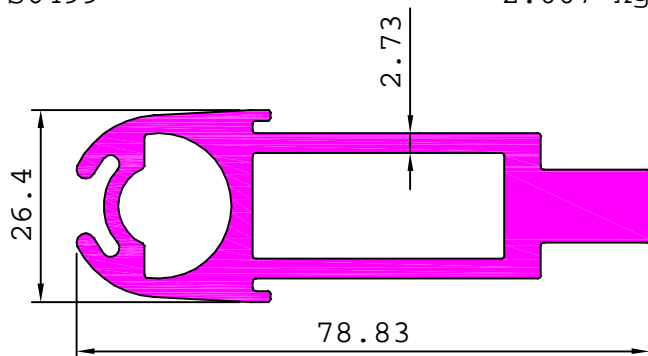

S6500

1.915 kg/m

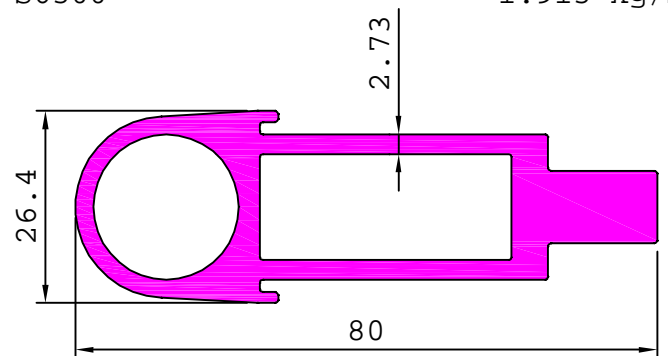

# MOULDING & TRANSPORT

## RAIL COACH

24588

0.256 kg/m

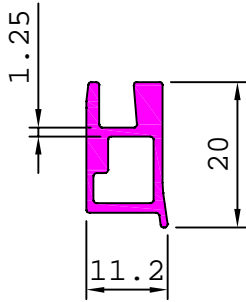

24587

1.033 kg/m

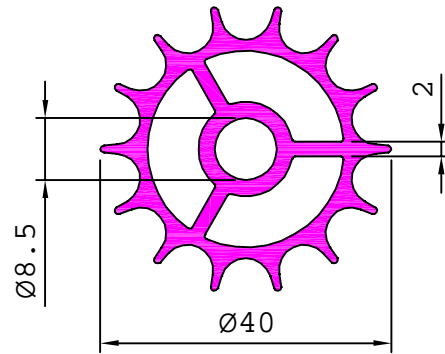

25420

6.712 kg/m

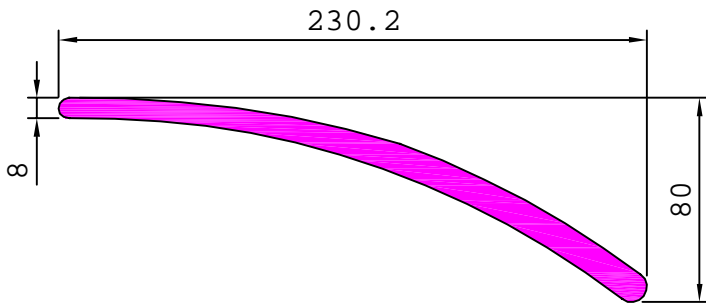

25419

2.912 kg/m

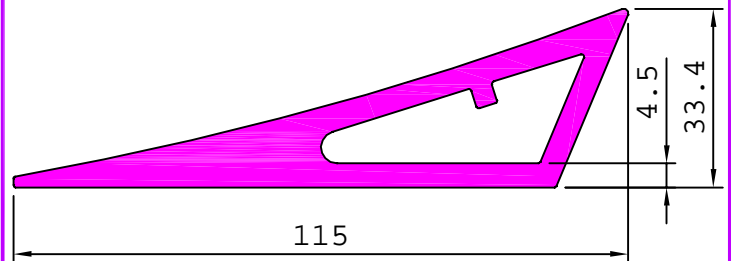

24590

4.123 kg/m

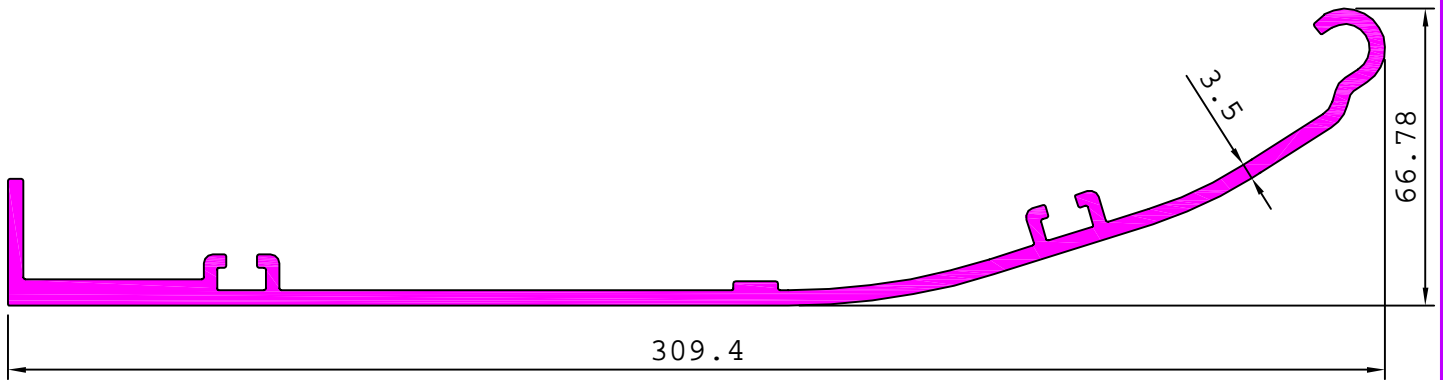

24586

3.502 kg/m

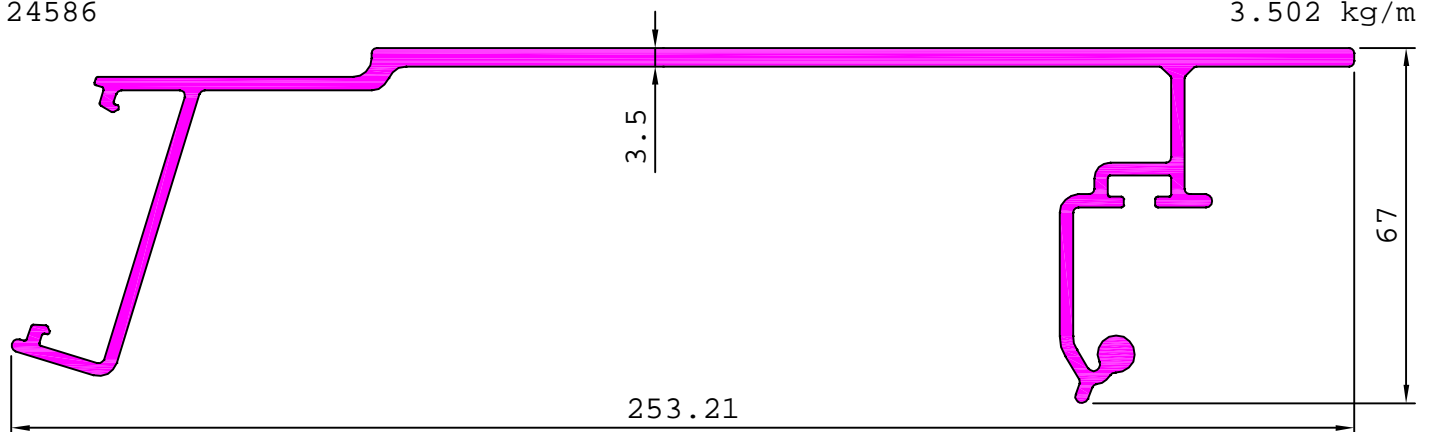

# MOULDING & TRANSPORT

## RAIL COACH

24524

0.217 kg/m

