

CONVEYOR SECTION

28606

3.856 kg/m

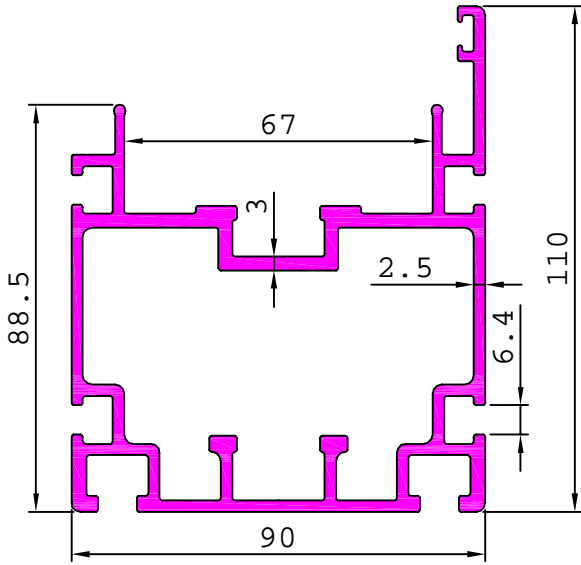

28609

3.615 kg/m

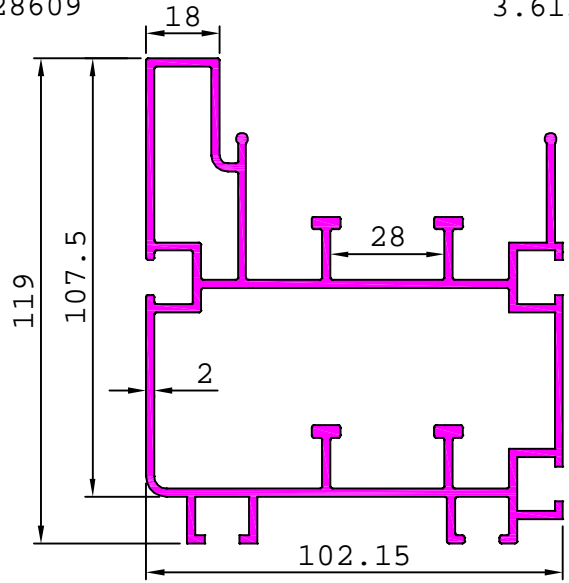

28678

6.175 kg/m

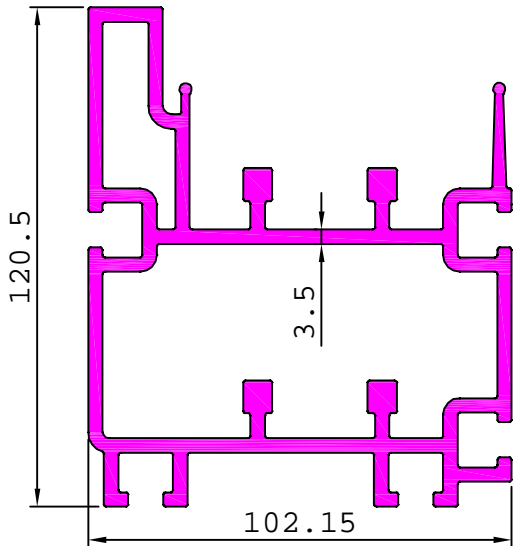

28626

6.119 kg/m

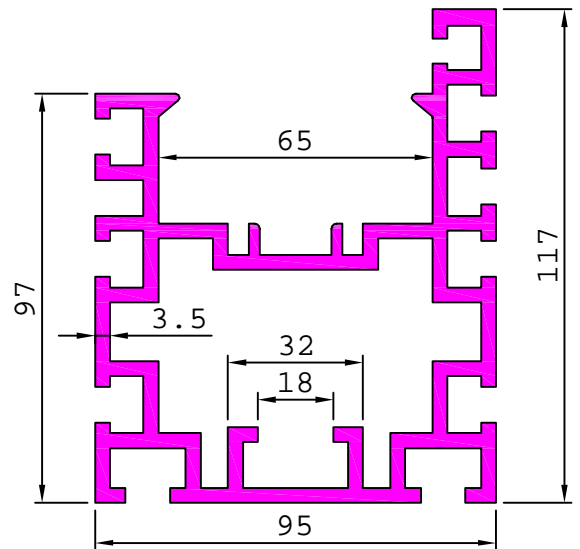

S6540

3.835 kg/m

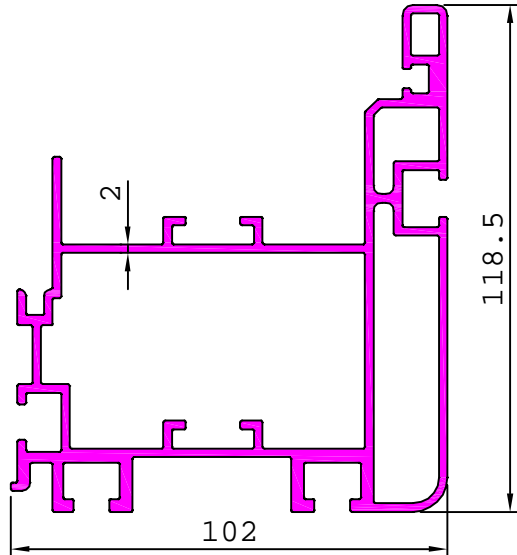

28680

6.197 kg/m

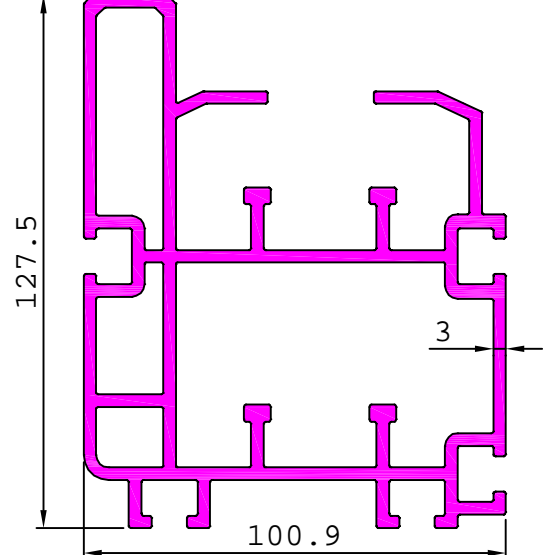

CONVEYOR SECTION

28639 7.483 kg/m

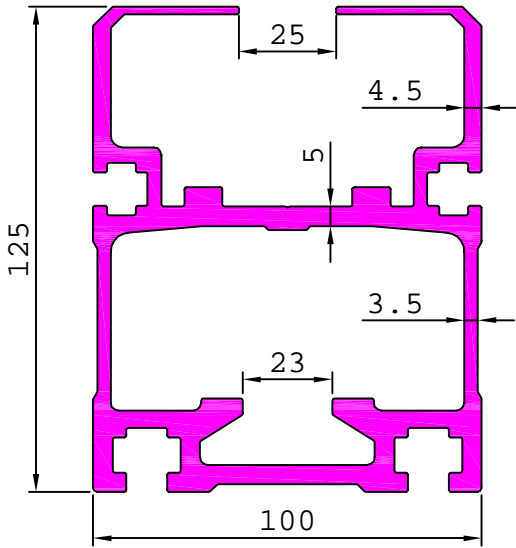

28640 4.480 kg/m

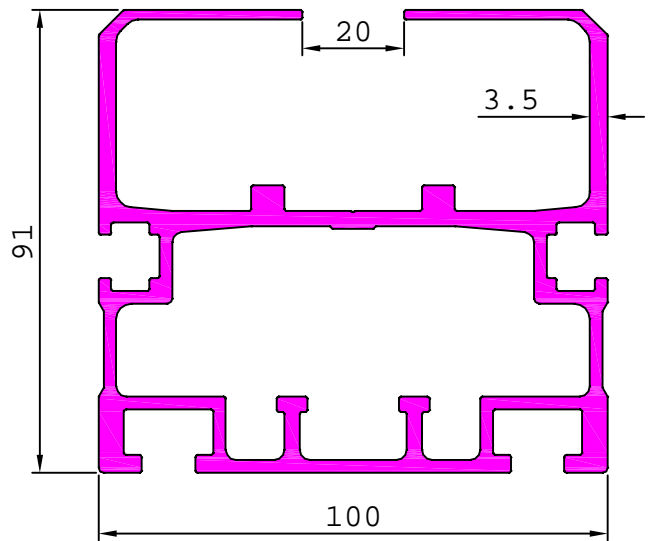

28645 3.677 kg/m

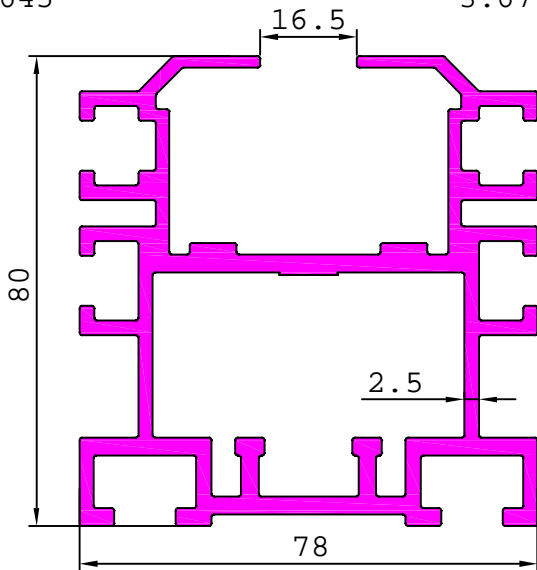

28674 4.523 kg/m

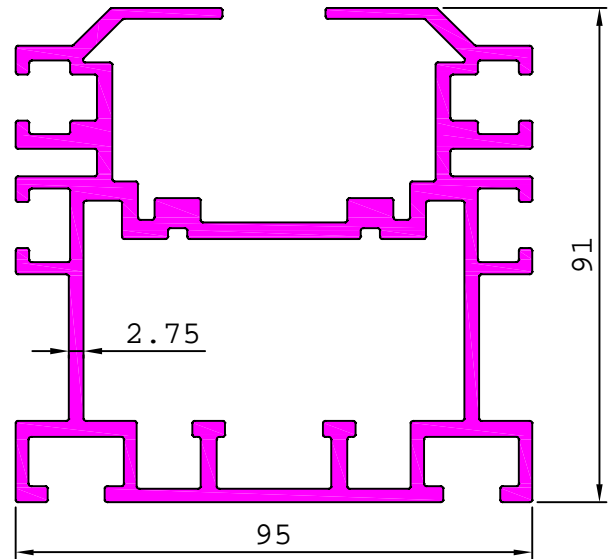

28662 11.236 kg/m

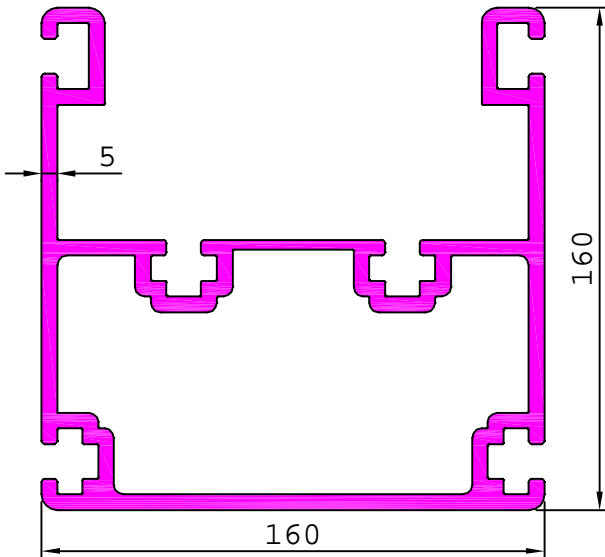

CONVEYOR SECTION

28601

0.532 kg/m

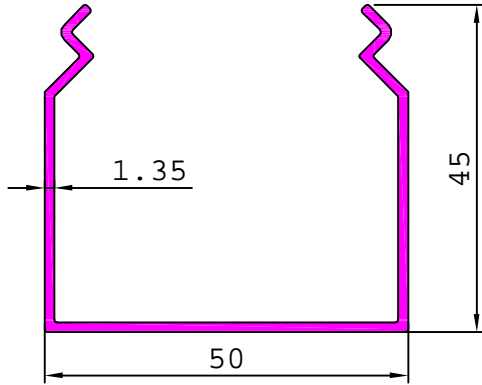

28602

0.284 kg/m

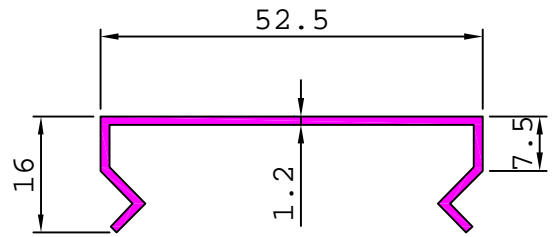

28603

3.495 kg/m

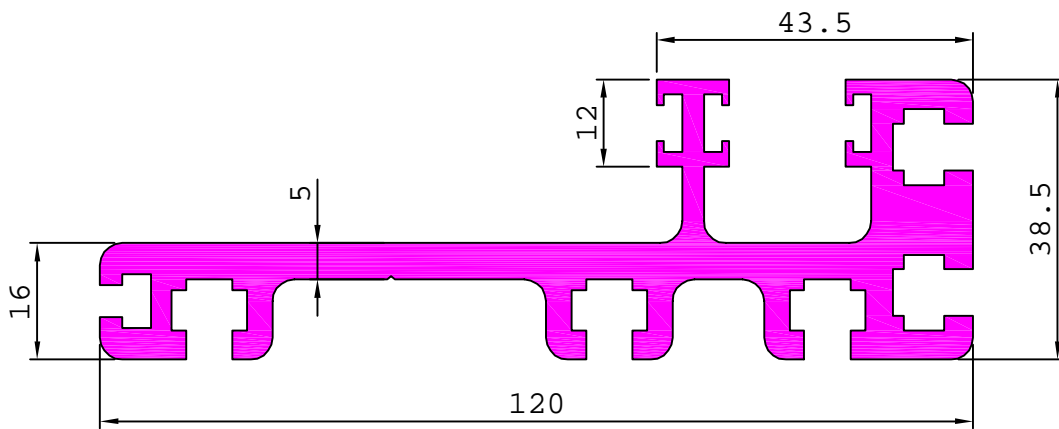

28604

1.394 kg/m

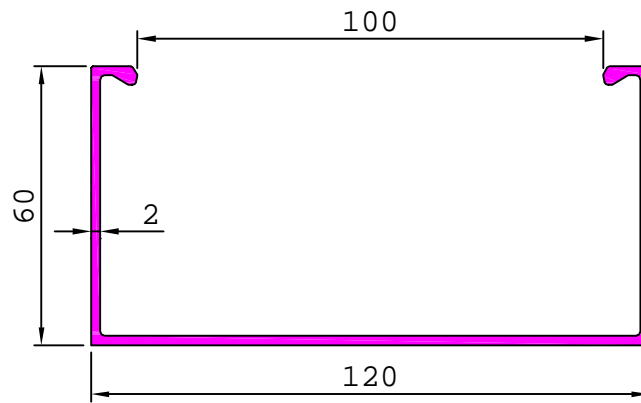

28605

0.830 kg/m

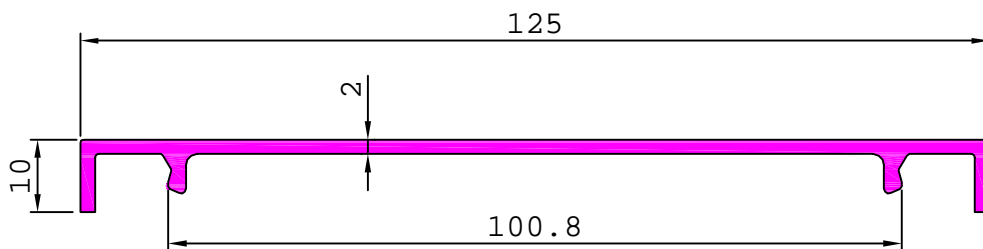

CONVEYOR SECTION

28608

3.057 kg/m

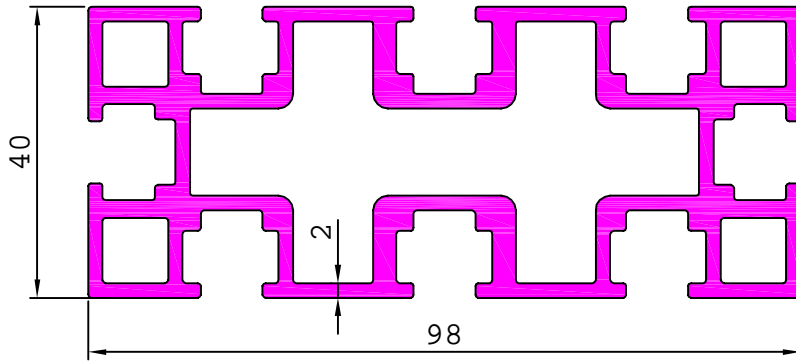

28611

3.096 kg/m

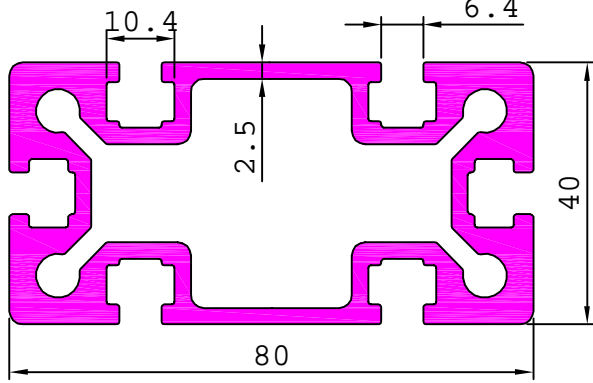

28612

1.298 kg/m

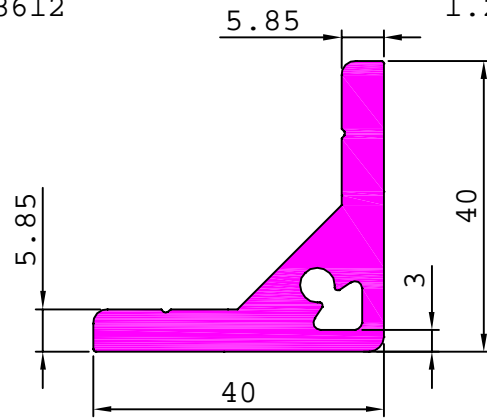

28614

4.300 kg/m

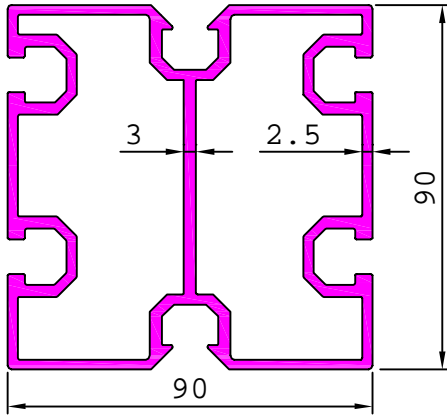

28615

5.360 kg/m

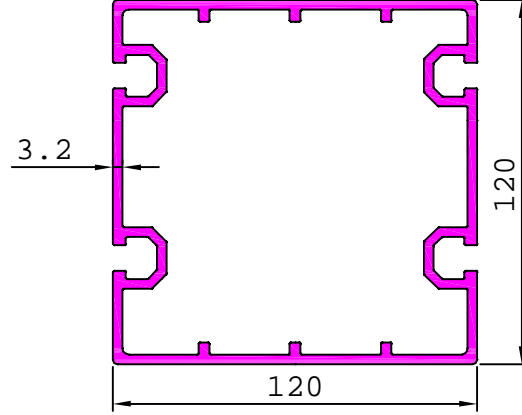

28616

2.648 kg/m

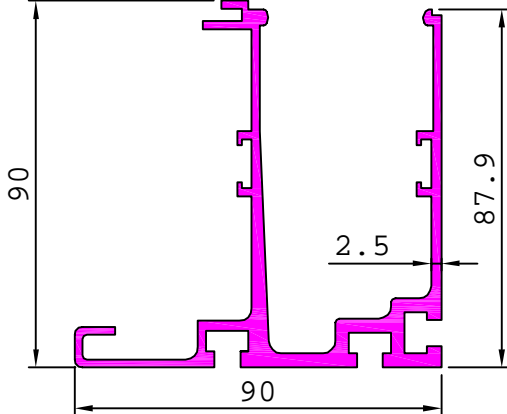

28618

1.733 kg/m

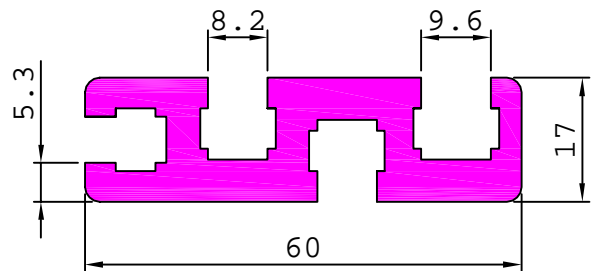

CONVEYOR SECTION

28619

1.506 kg/m

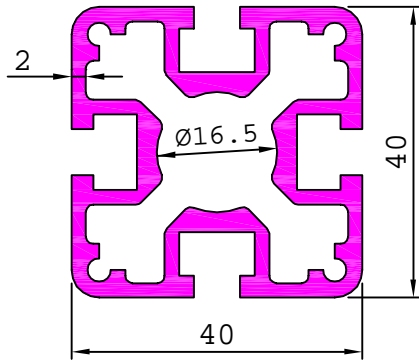

28620

1.070 kg/m

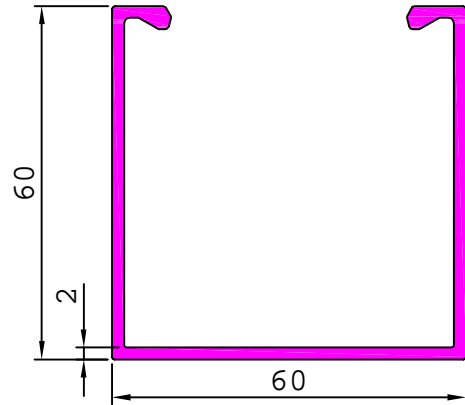

28621

0.504 kg/m

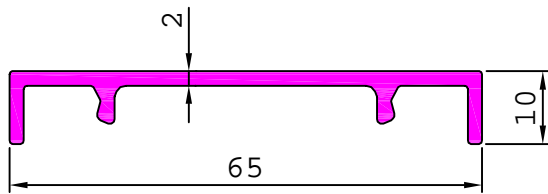

28623

6.493 kg/m

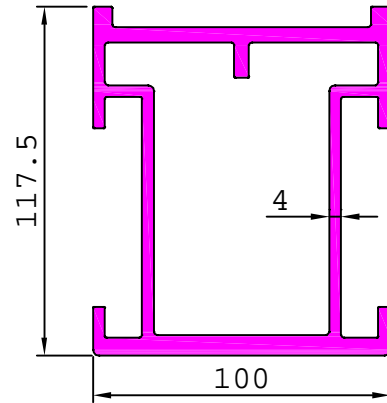

28627

4.094 kg/m

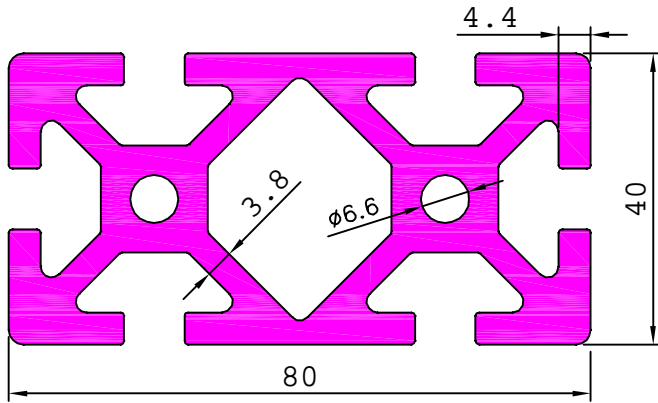

28630

7.368 kg/m

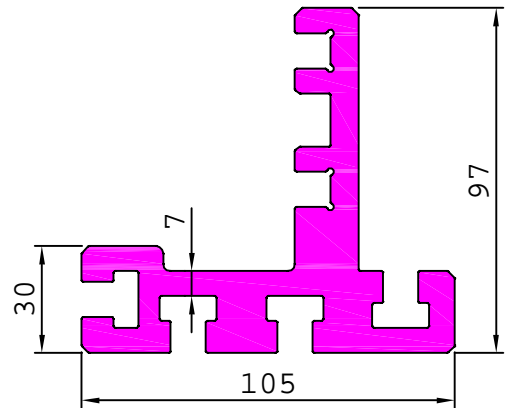

28631

5.942 kg/m

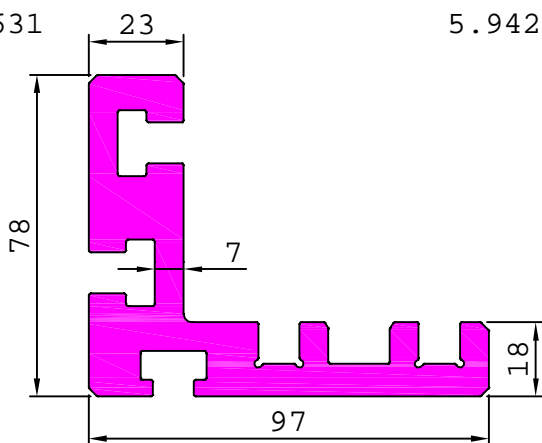

28637

0.986 kg/m

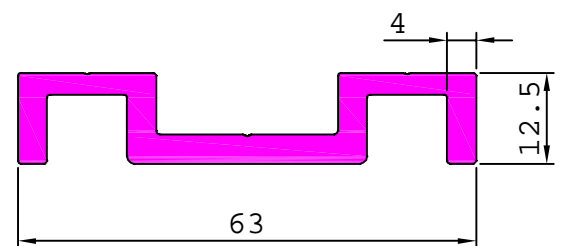

CONVEYOR SECTION

28642

6.012 kg/m

28646

0.421 kg/m

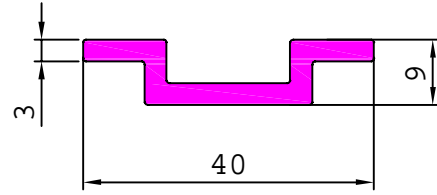
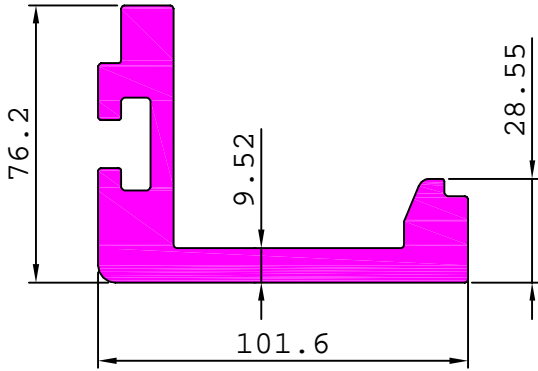

28644

7.972 kg/m

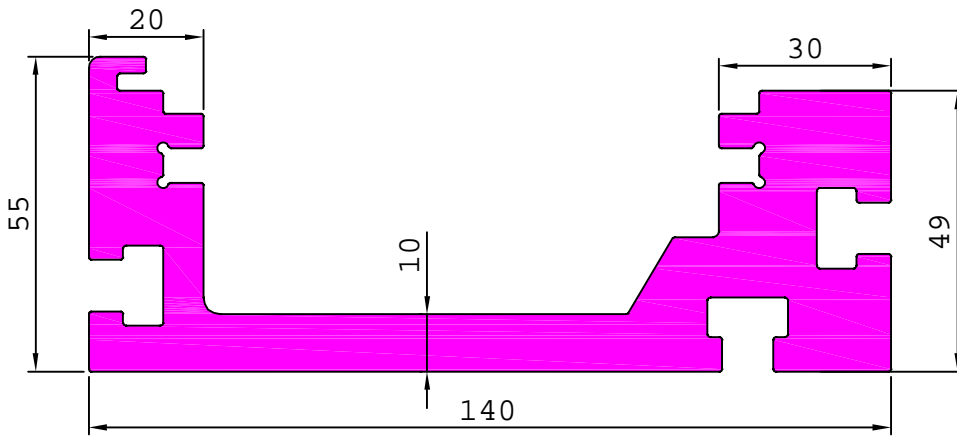

28647

5.329 kg/m

28648

5.654 kg/m

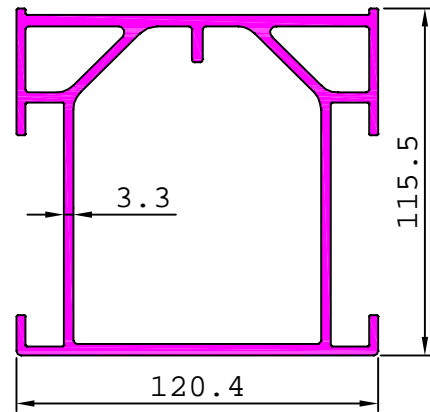
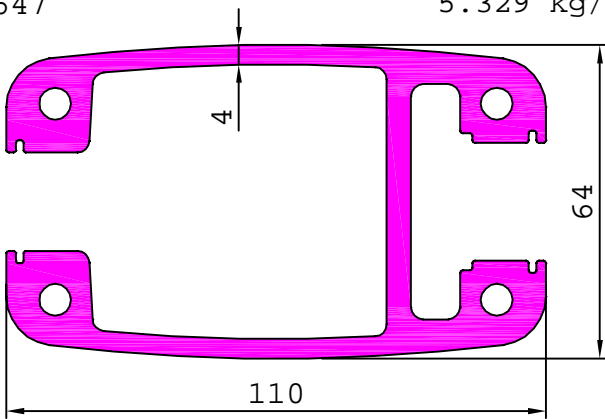

28649

12.173 kg/m

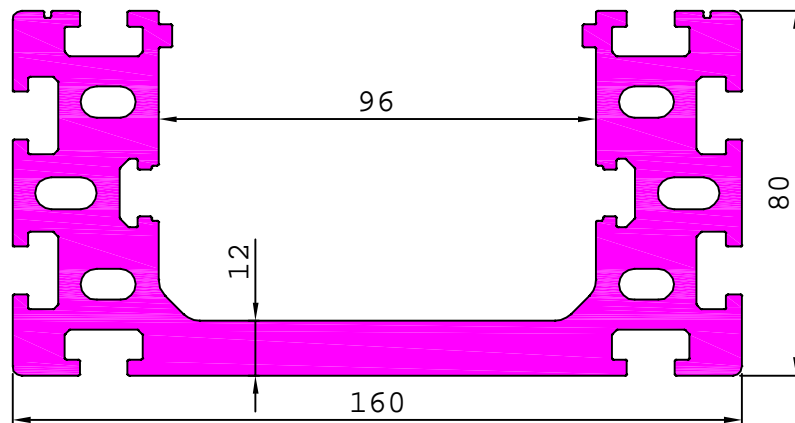

CONVEYOR SECTION

28651

1.575 kg/m

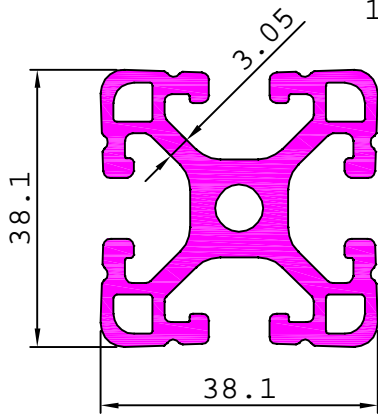

28656

6.205 kg/m

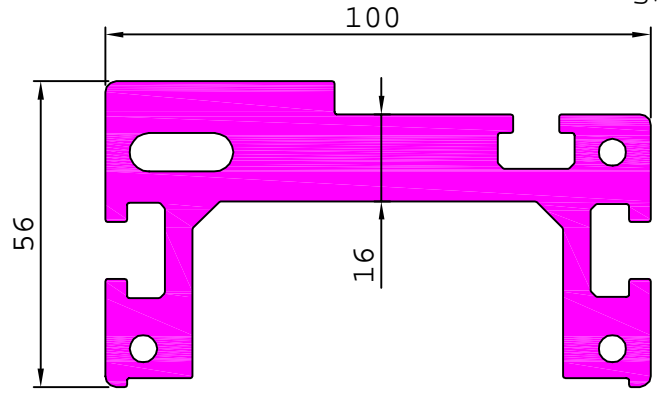

28653

5.775 kg/m

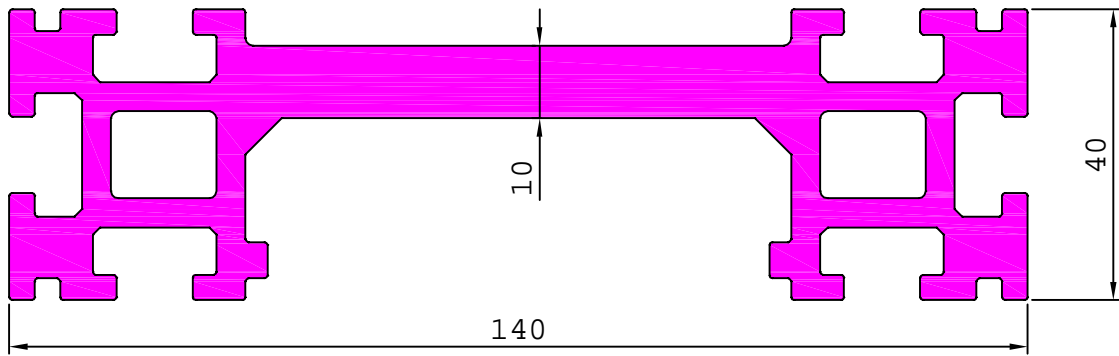

28657

4.883 kg/m

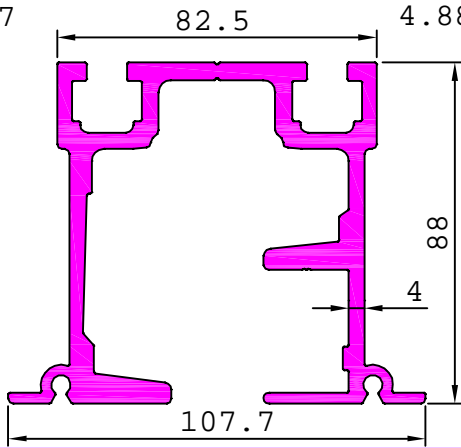

28660

2.971 kg/m

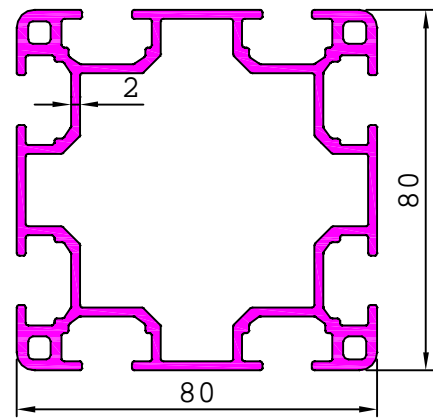

28663

4.661 kg/m

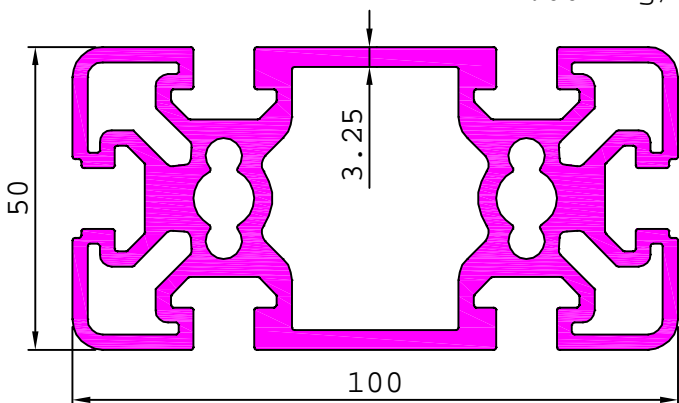

28664

1.889 kg/m

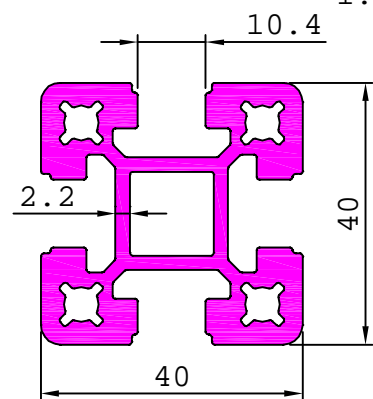

CONVEYOR SECTION

28665

10.009 kg/m

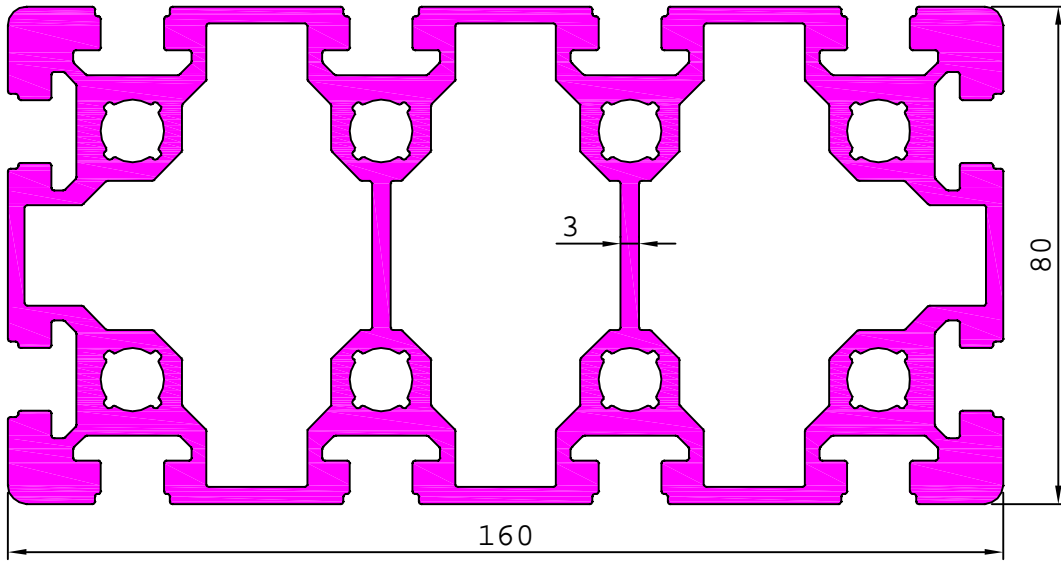

28667

13.329 kg/m

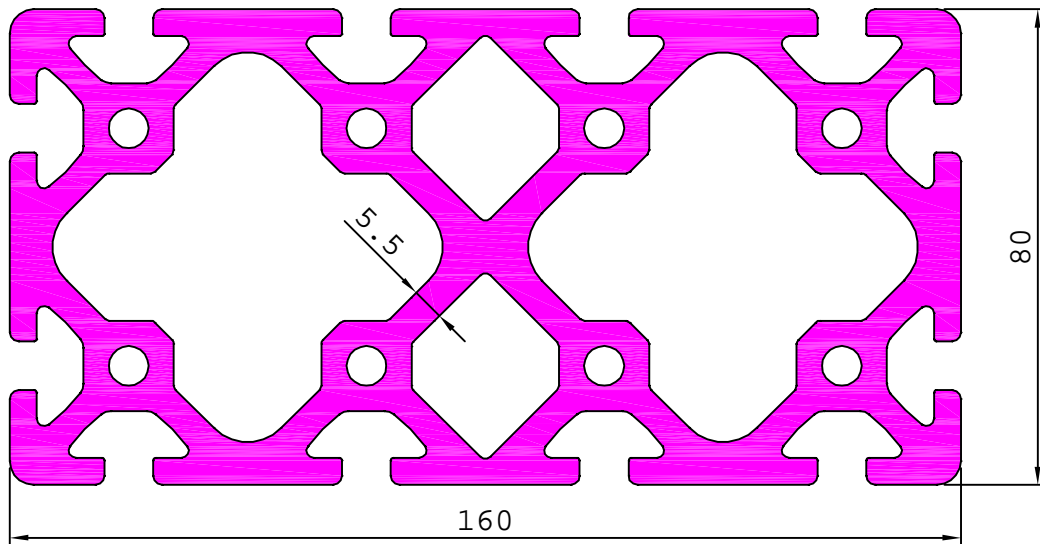

28671

13.108 kg/m

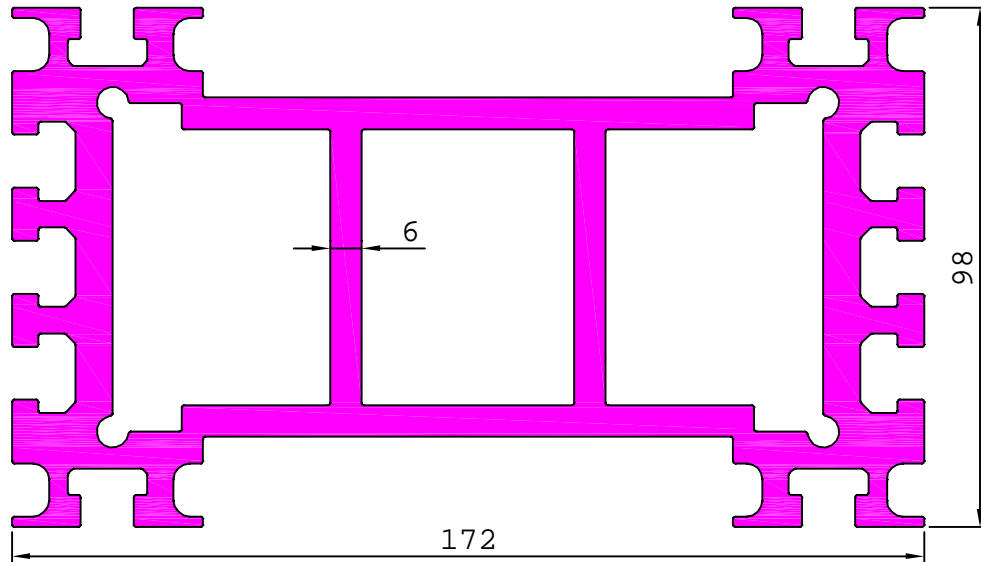

CONVEYOR SECTION

28666

1.398 kg/m

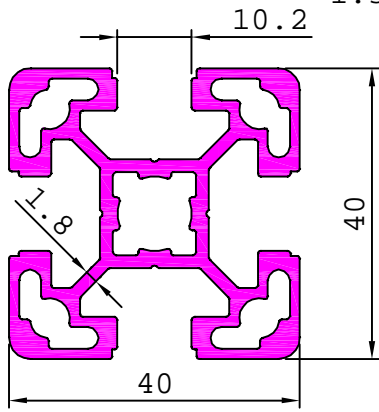

28668

3.903 kg/m

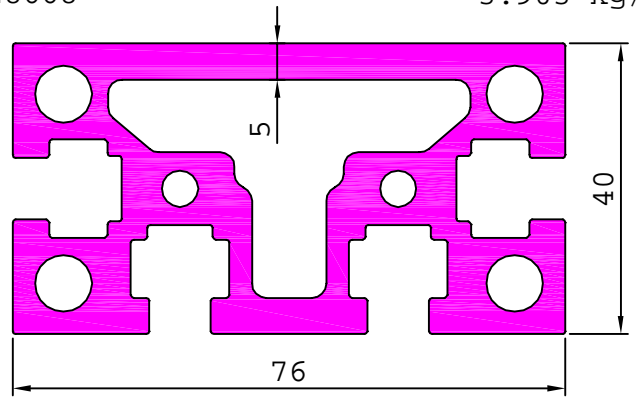

28669

5.509 kg/m

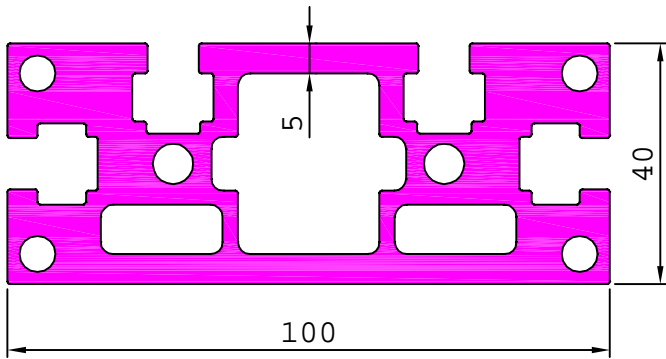

28670

8.148 kg/m

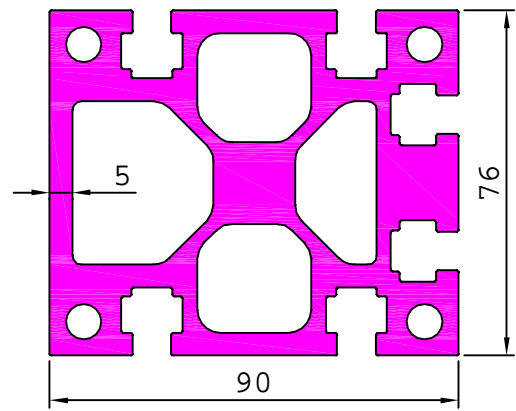

28672

2.905 kg/m

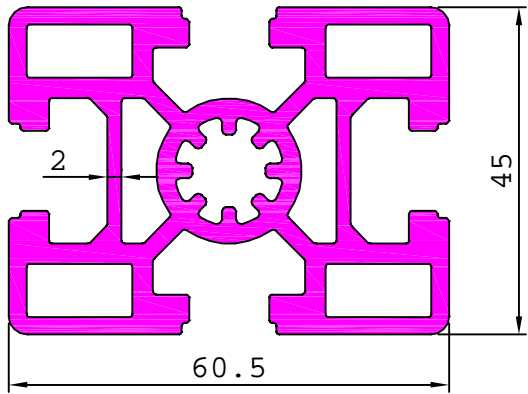

28673

0.427 kg/m

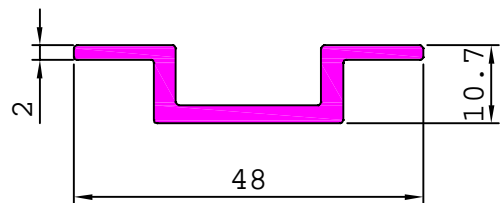

28675

1.692 kg/m

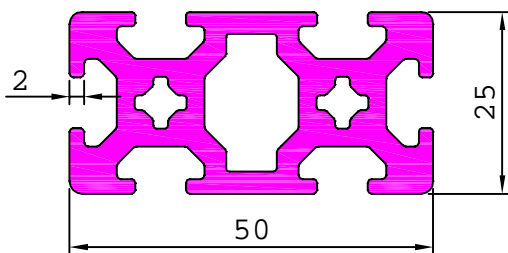

28676

1.161 kg/m

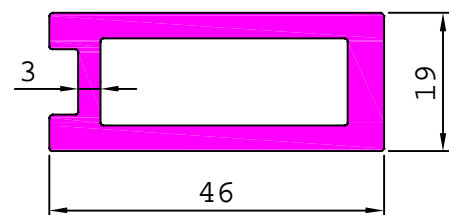

CONVEYOR SECTION

28677

2.606 kg/m

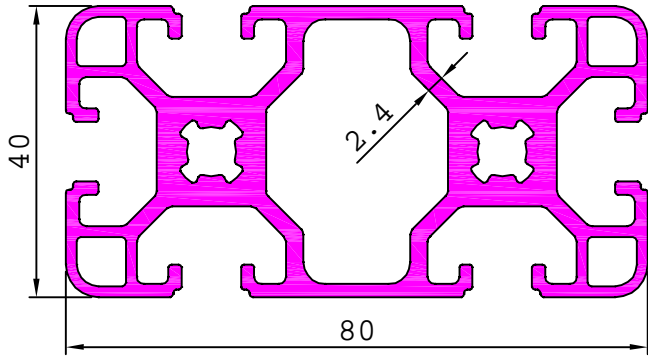

28681

2.484 kg/m

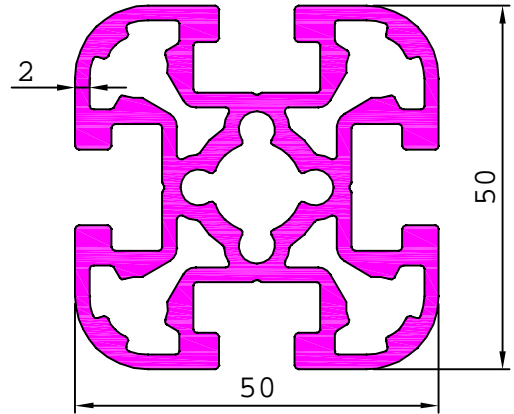

28683

1.635 kg/m

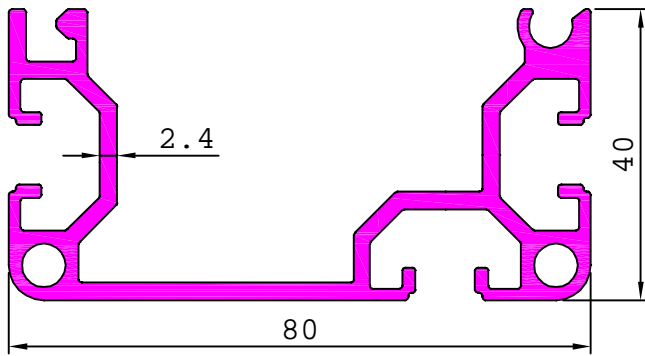

28432

9.257 kg/m

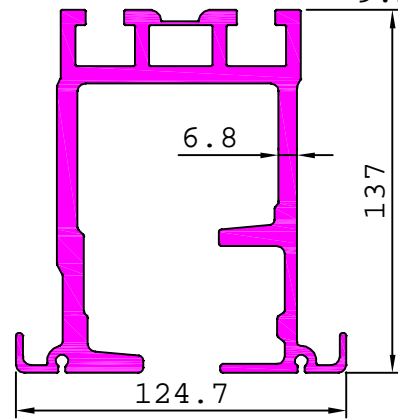

28685

0.853 kg/m

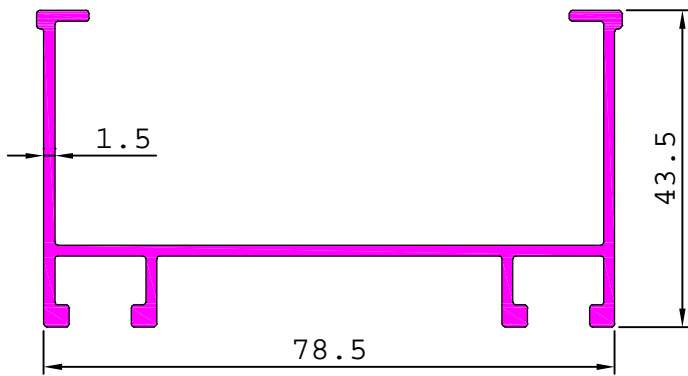

28936

8.473 kg/m

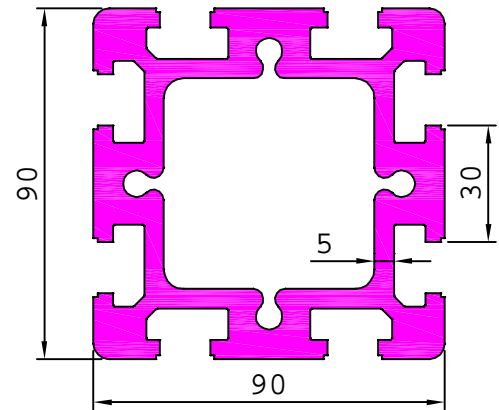

28778

1.818 kg/m

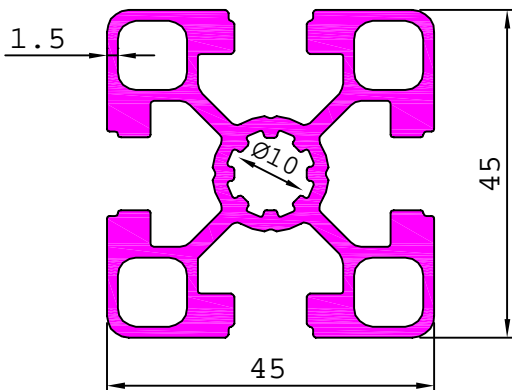

21812

0.885 kg/m

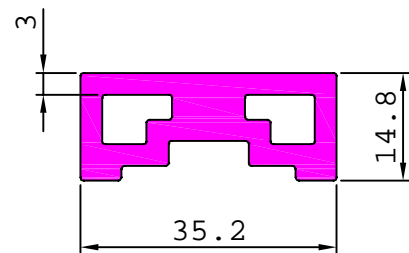

CONVEYOR SECTION

28679

6.021 kg/m

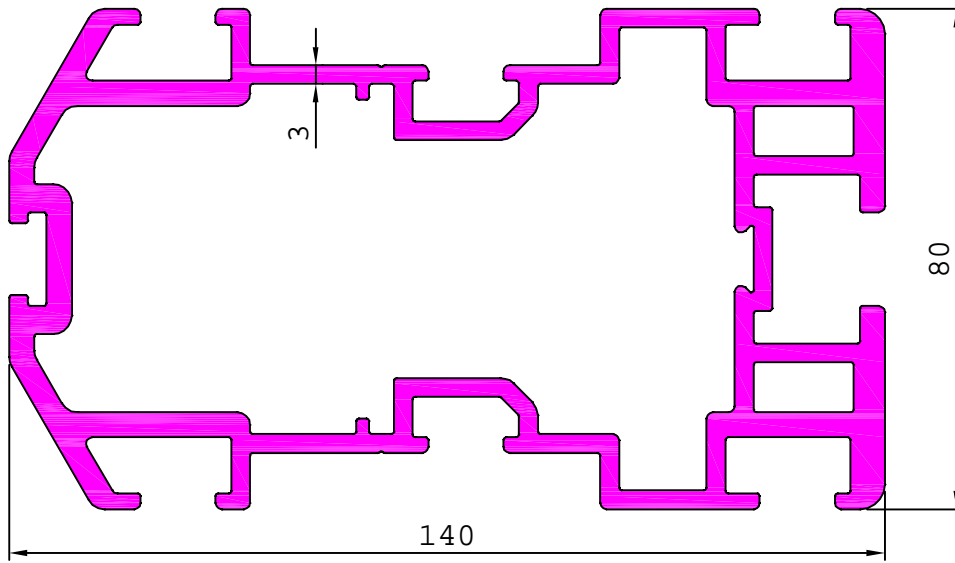

28682

25.585 kg/m

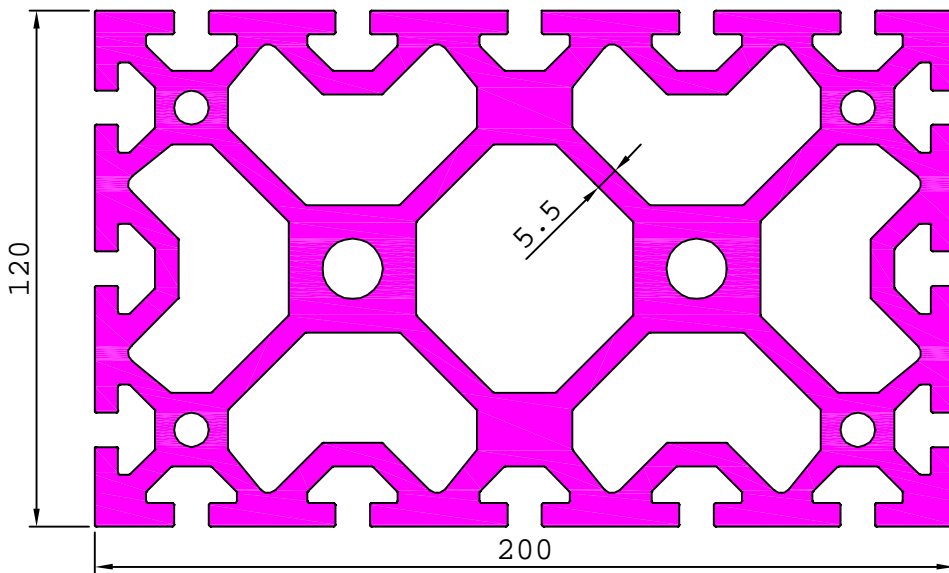

28521

10.825 kg/m

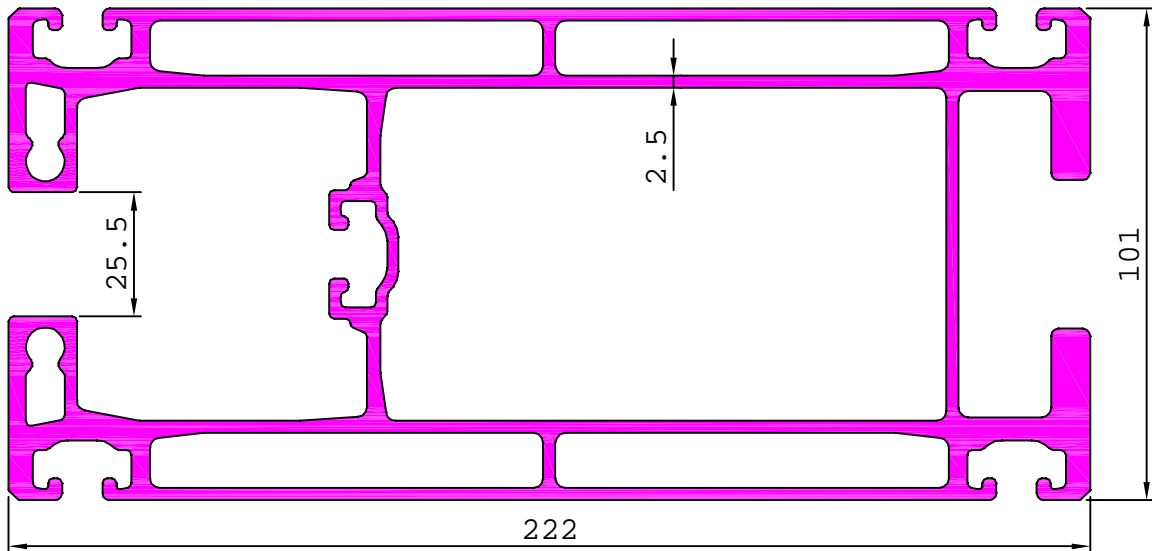

CONVEYOR SECTION

28481

6.772 kg/m

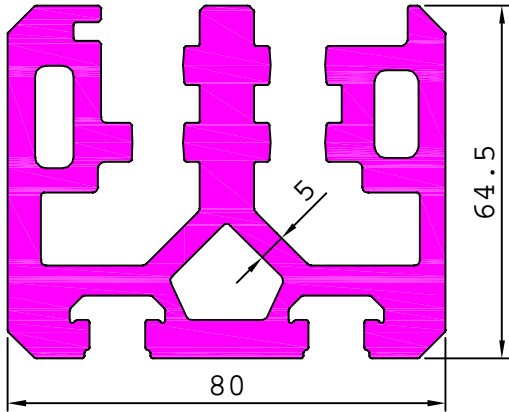

43508

5.073 kg/m

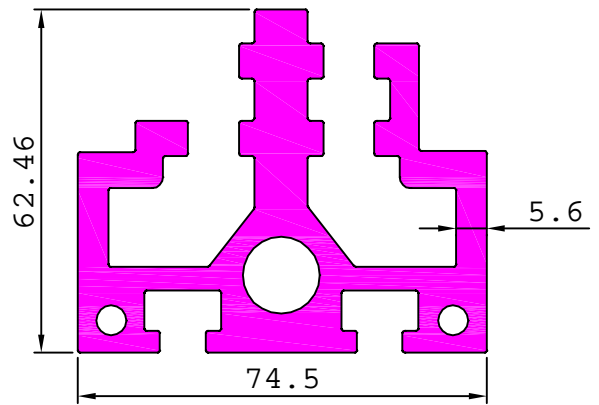

28362

3.939 kg/m

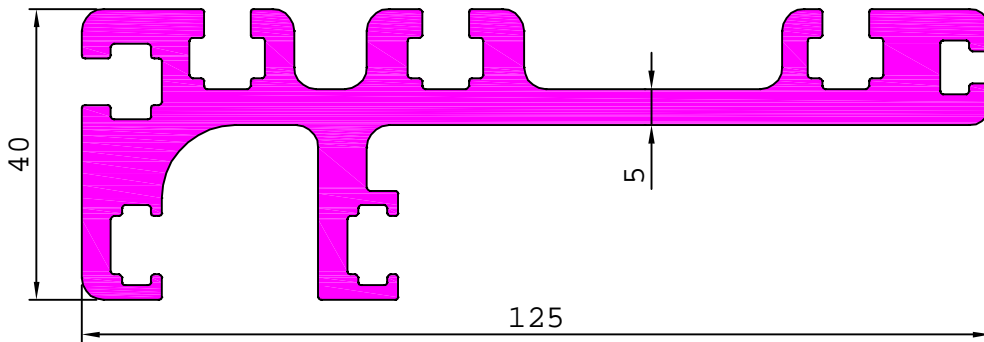

29598

12.170 kg/m

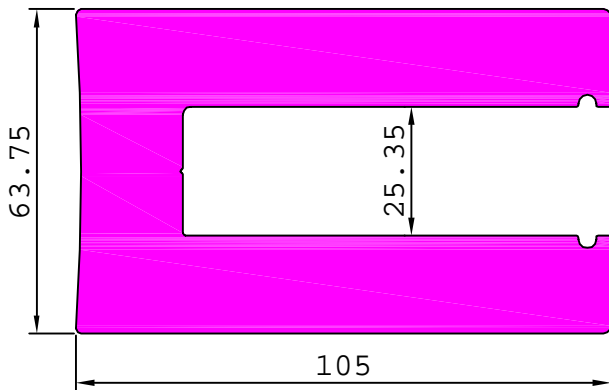

S4815

7.699 kg/m

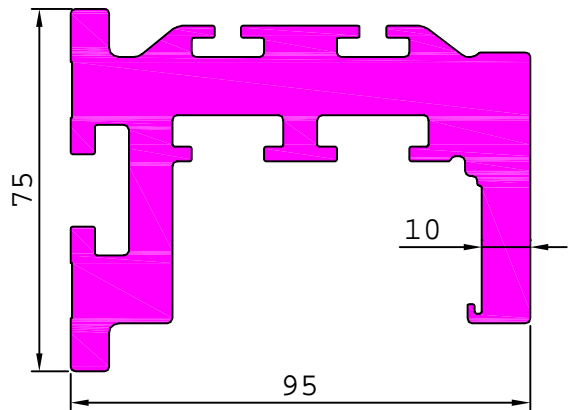

27808

7.106 kg/m

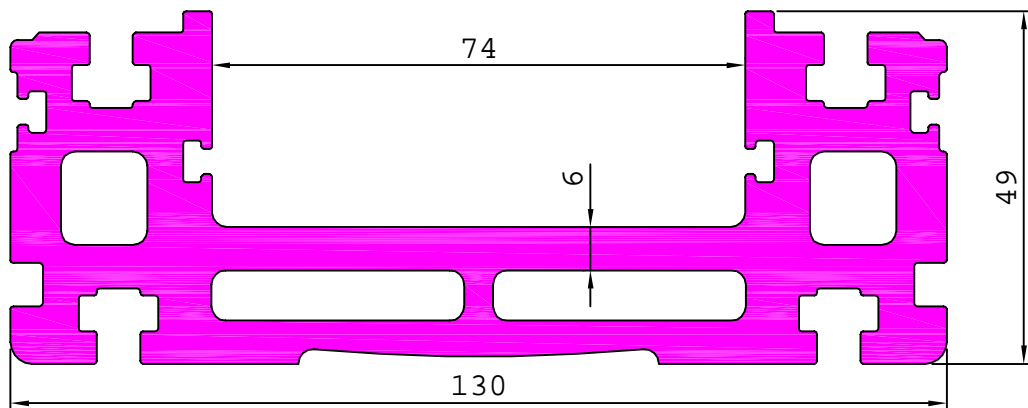

CONVEYOR SECTION

28000

11.252 kg/m

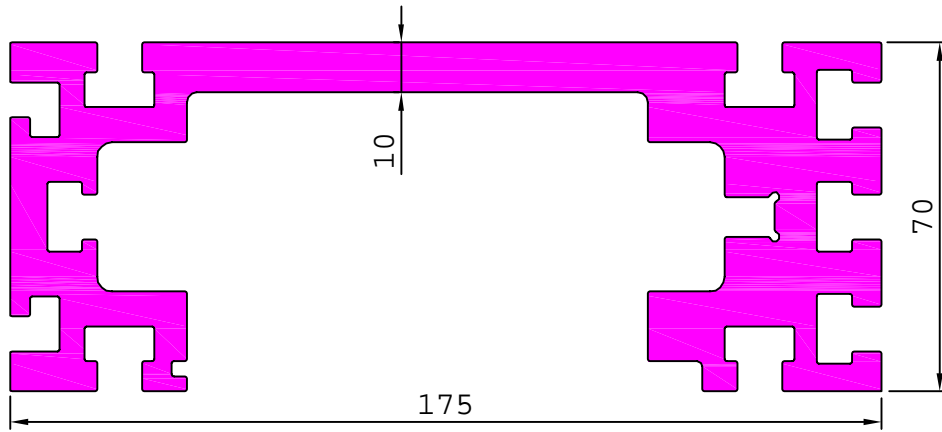

S6356

14.340 kg/m

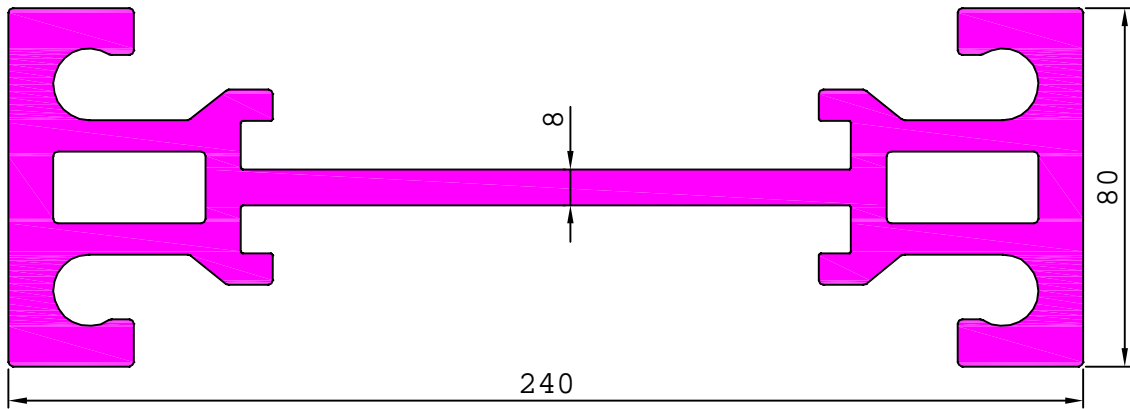

27859

3.686 kg/m

28687

0.269 kg/m

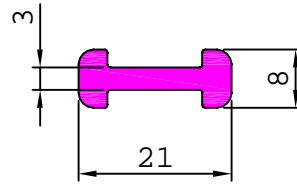
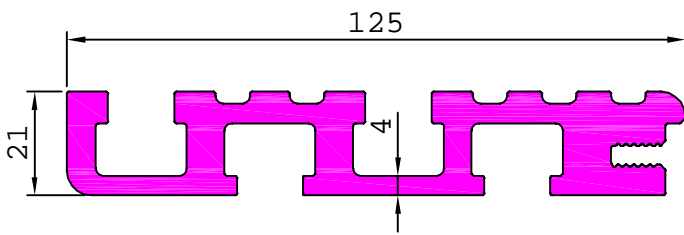

28686

155

3.717 kg/m

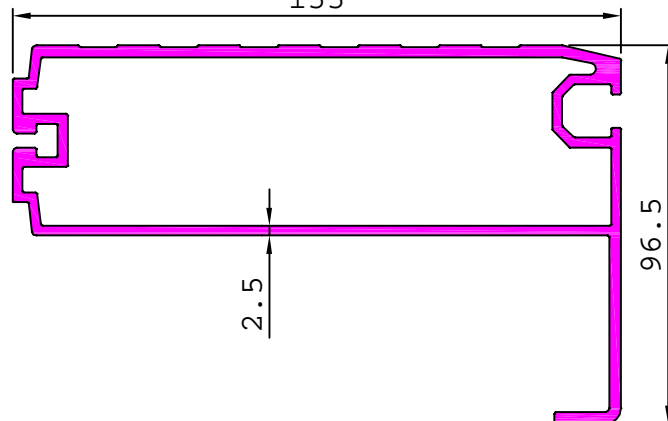

CONVEYOR SECTION

G100892

0.348 kg/m

