

# INDUSTRIAL

## ELECTRONICS

25755

0.353 kg/m

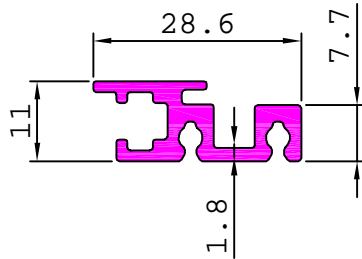

25724

0.273 kg/m

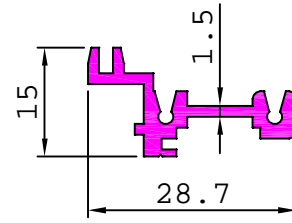

25828

0.367 kg/m

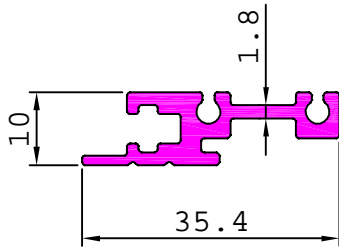

25812

0.353 kg/m

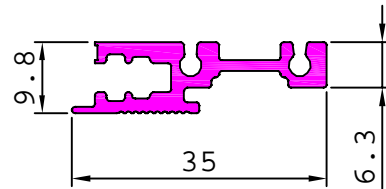

27414

0.398 kg/m

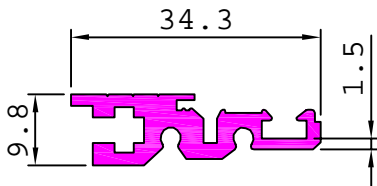

25065

0.708 kg/m

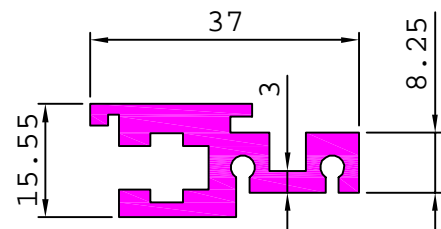

S6229

0.301 kg/m

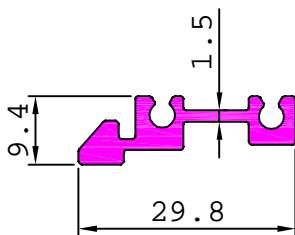

G100941

0.407 kg/m

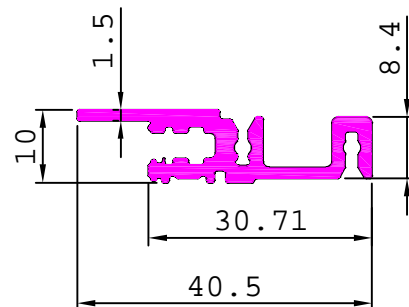

# INDUSTRIAL

## ELECTRONICS

25775

0.351 kg/m

25827

0.217 kg/m

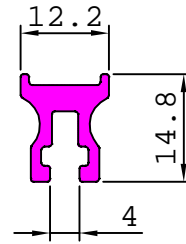
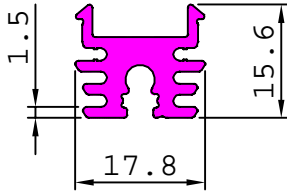

25736

0.169 kg/m

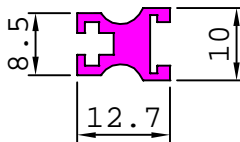

# INDUSTRIAL

## ELECTRONICS

25816

0.374 kg/m

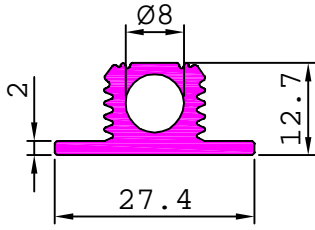

25818

0.468 kg/m

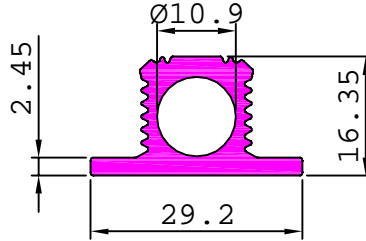

29003

0.458 kg/m

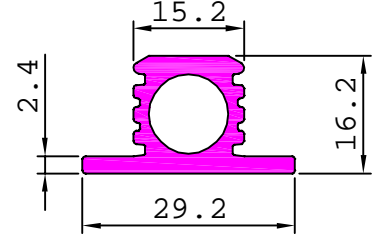

25817

3.069 kg/m

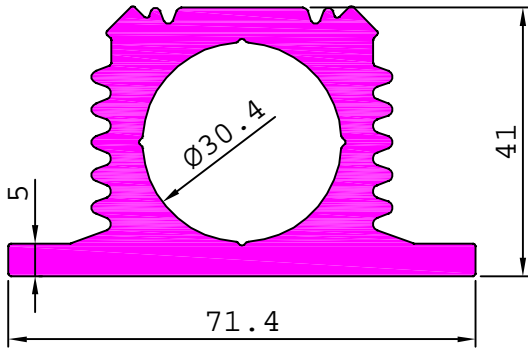

29195

2.561 kg/m

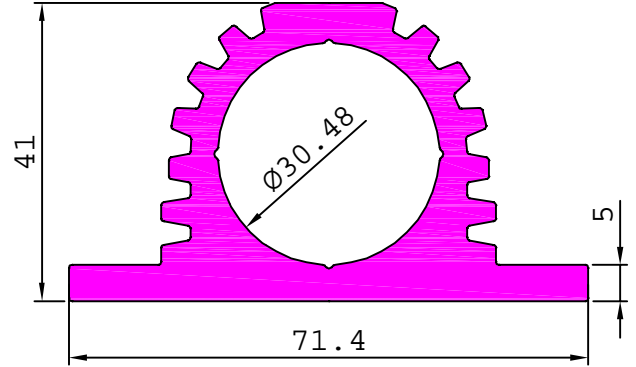

25819

1.169 kg/m

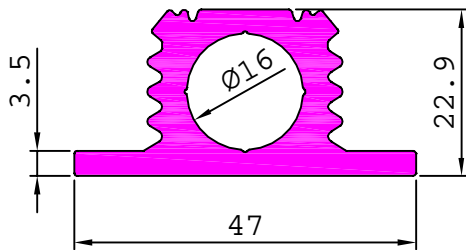

**ELECTRONICS**

25804

7.576 kg/m

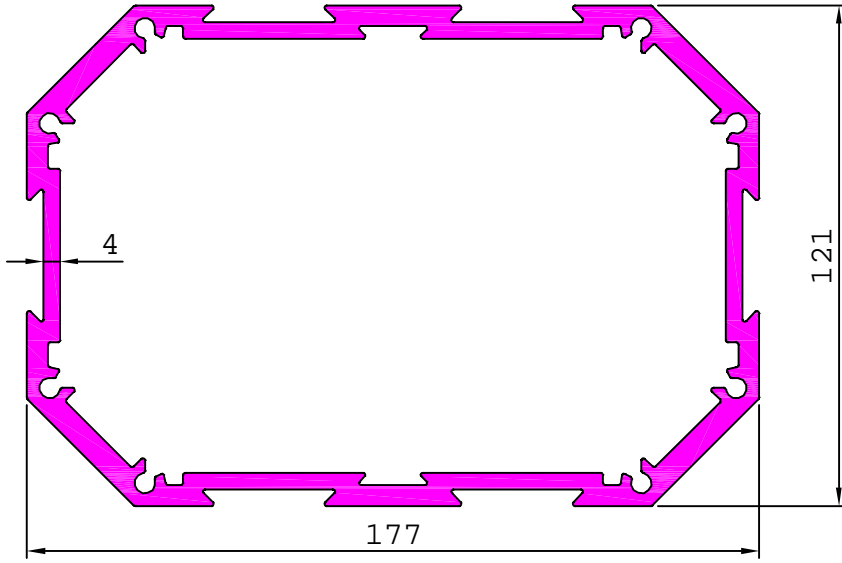

25805

8.652 kg/m

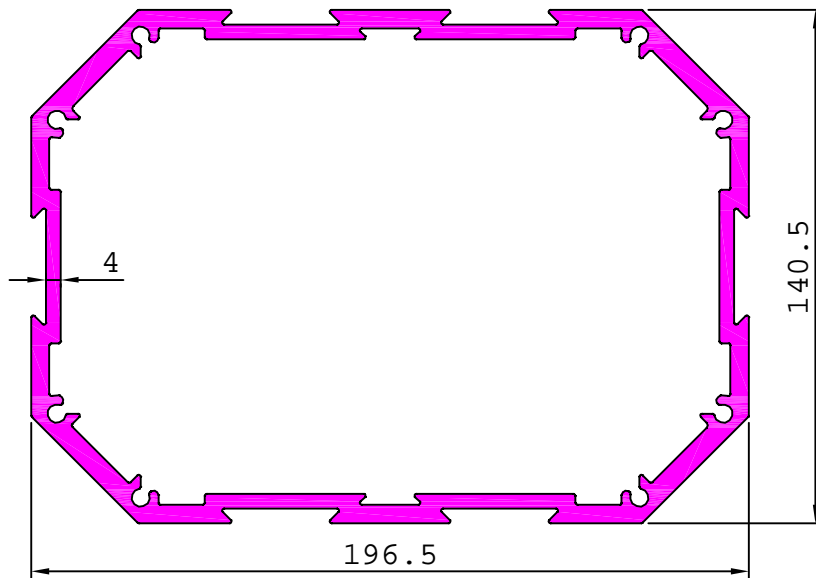

25830

10.206 kg/m

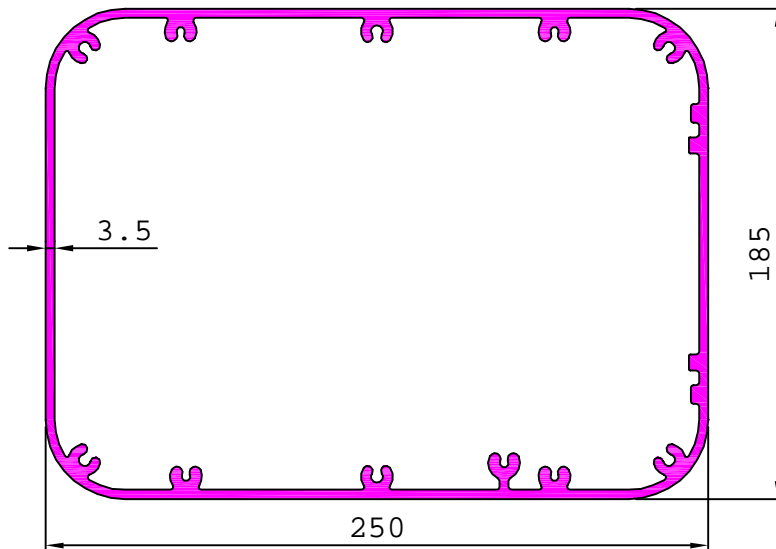

**ELECTRONICS**

29683

8.130 kg/m

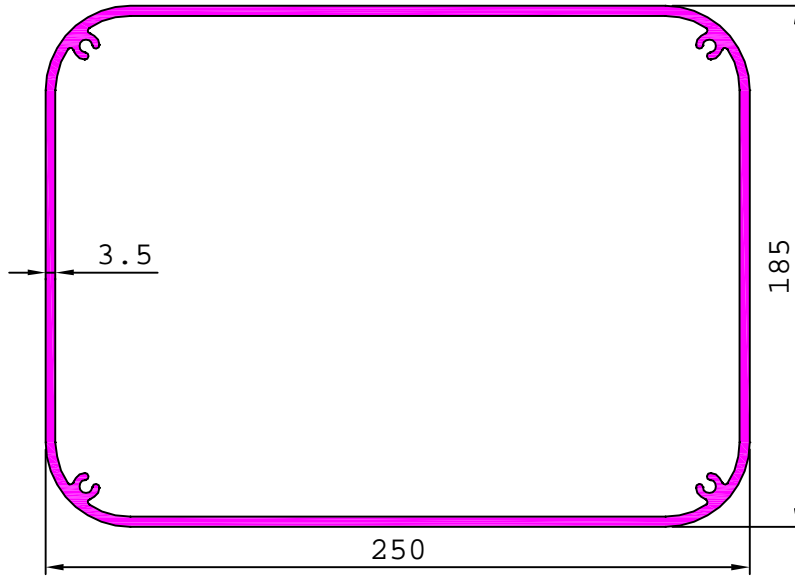

25841

7.373 kg/m

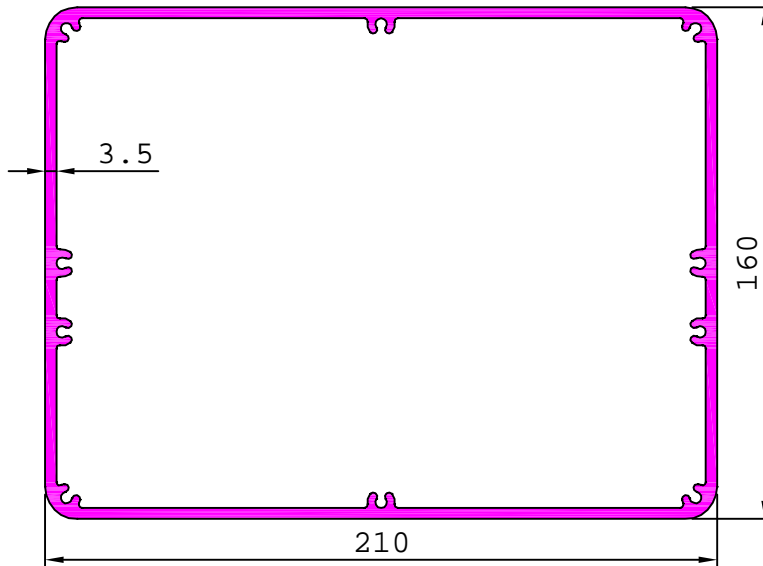

25414

5.102 kg/m

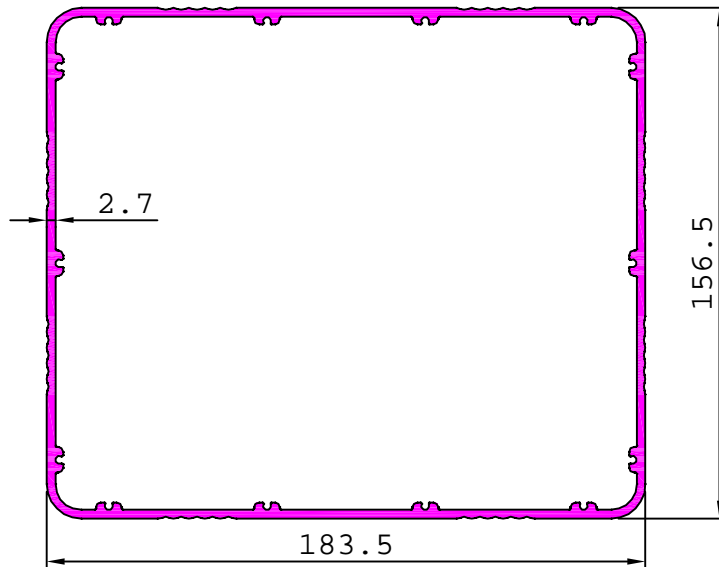

ELECTRONICS

28144

4.240 kg/m

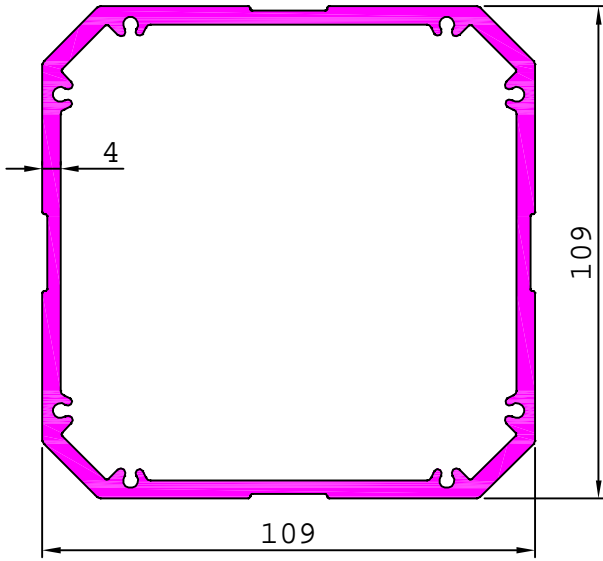

29563

4.650 kg/m

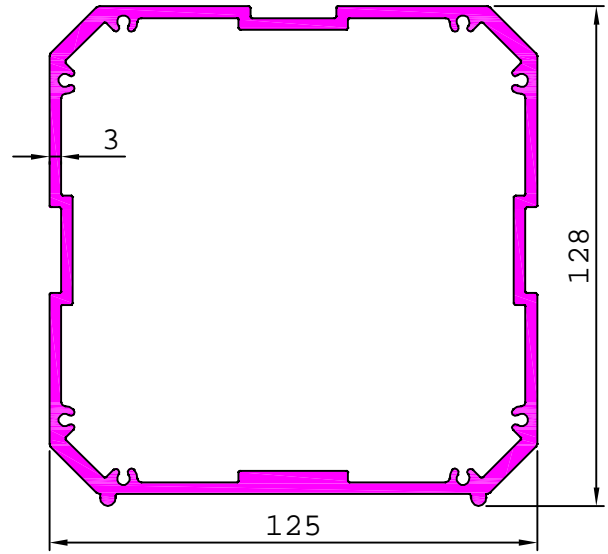

25175

6.210 kg/m

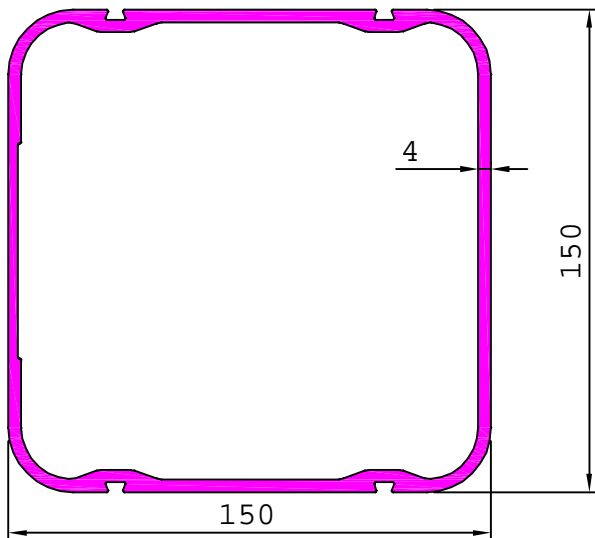

28938

3.488 kg/m

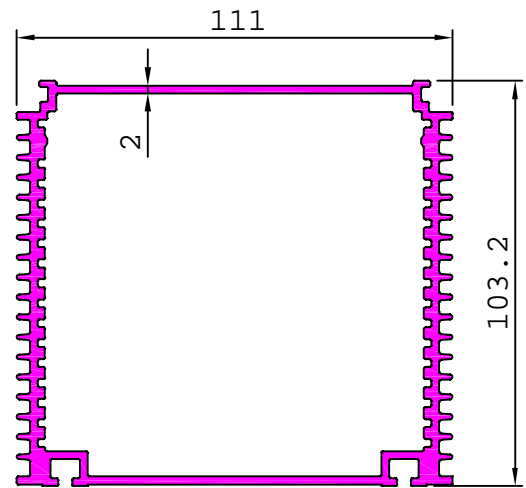

27611

2.256 kg/m

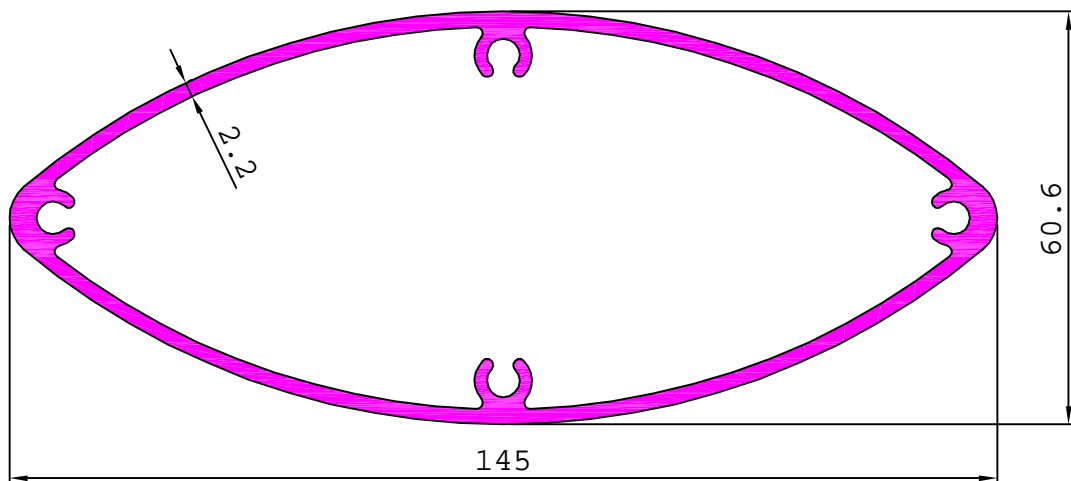

**ELECTRONICS**

S6529

21.593 kg/m

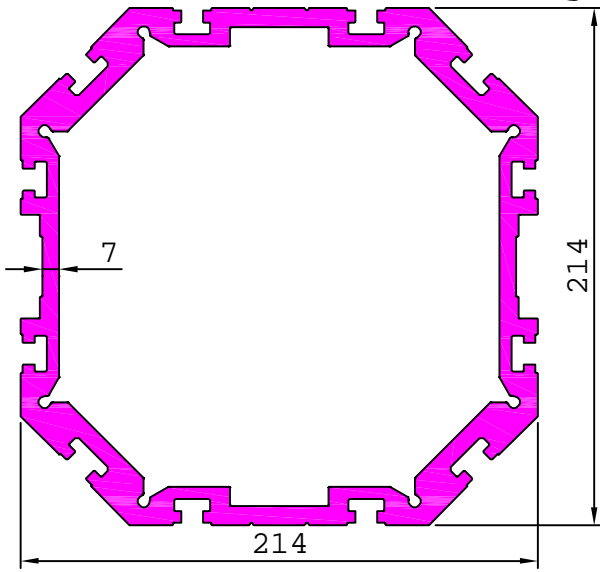

S6530

15.579 kg/m

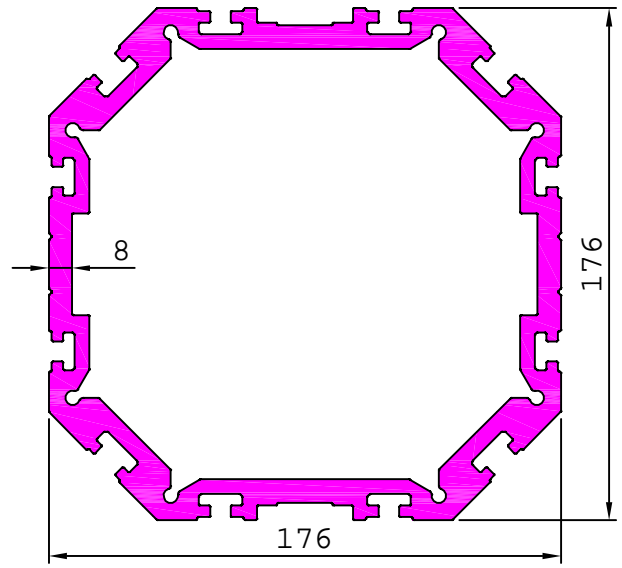

S6531

12.270 kg/m

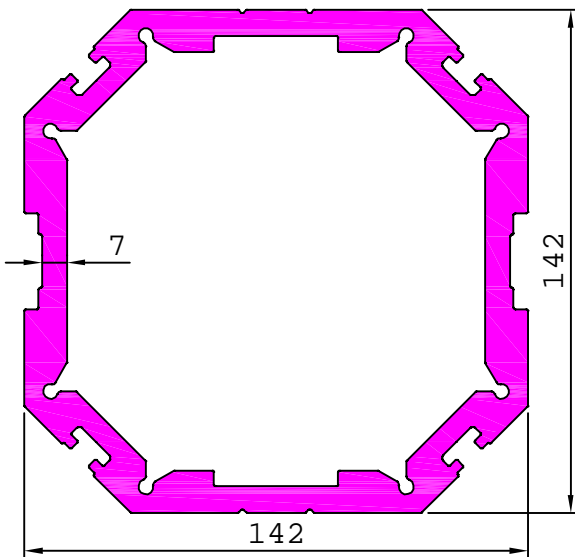

S6532

8.628 kg/m

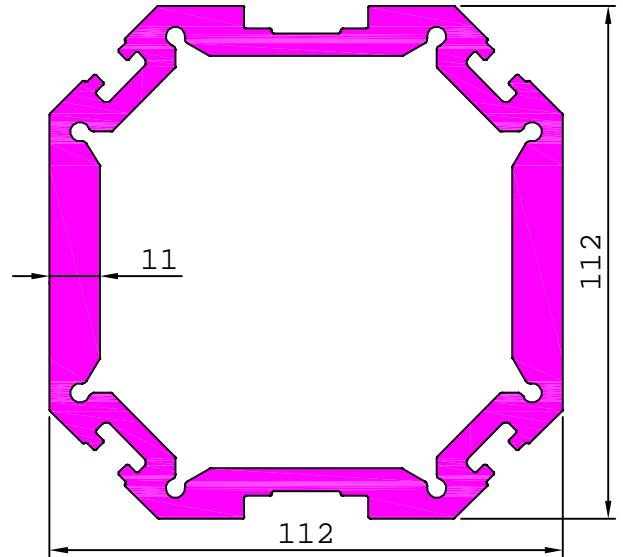

ELECTRONICS

25748

1.387 kg/m

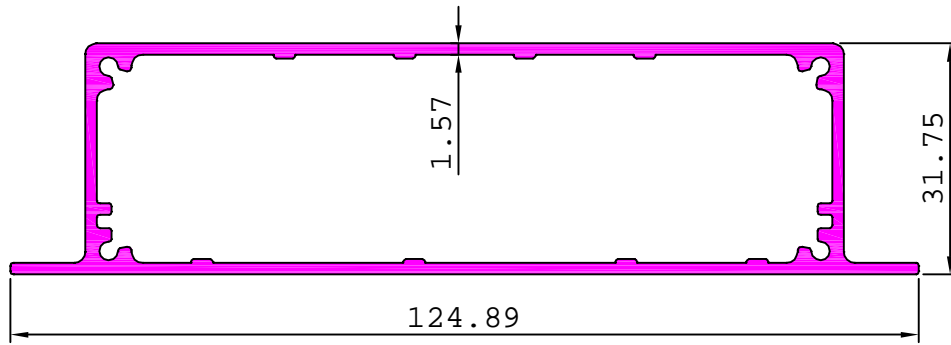

25768

0.781 kg/m

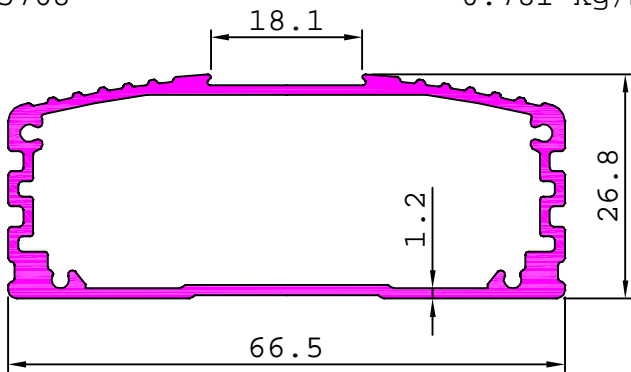

25771

1.633 kg/m

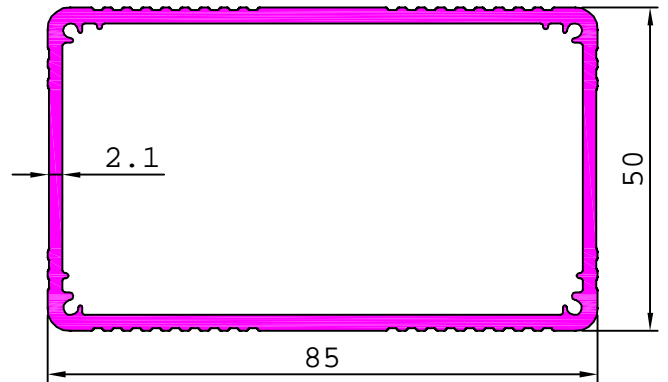

25773

2.094 kg/m

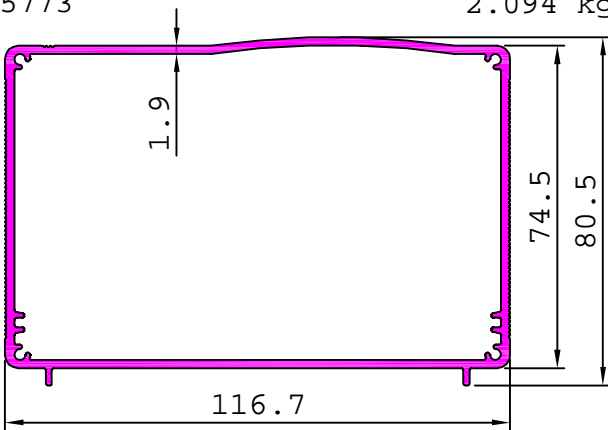

25776

1.665 kg/m

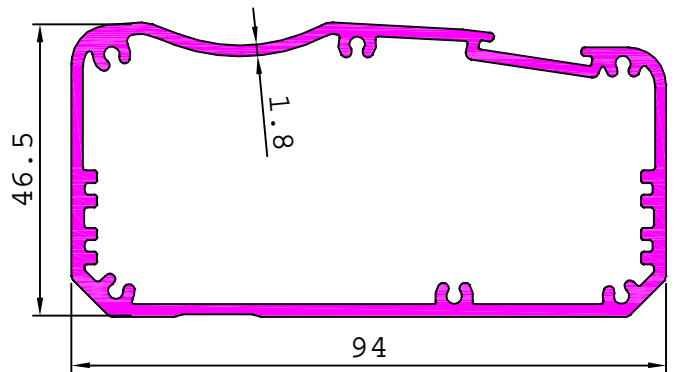

25779

2.321 kg/m

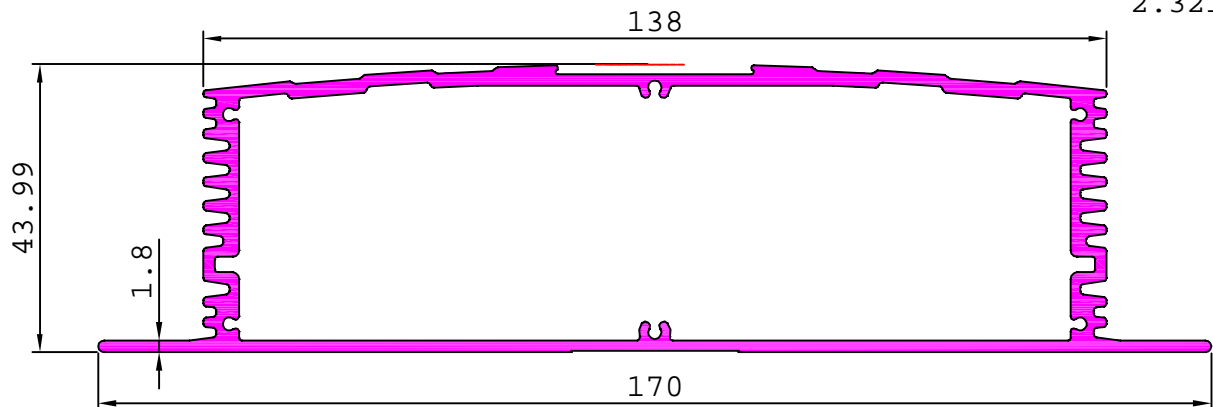



ELECTRONICS

25780

1.613 kg/m

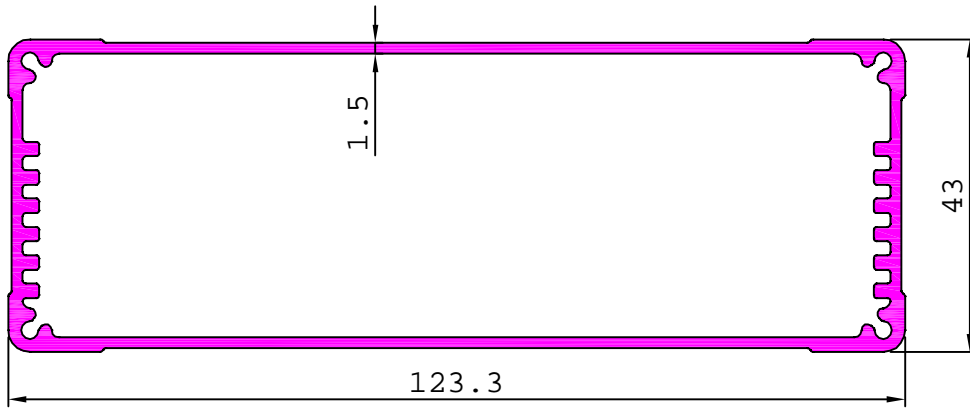

25809

2.085 kg/m

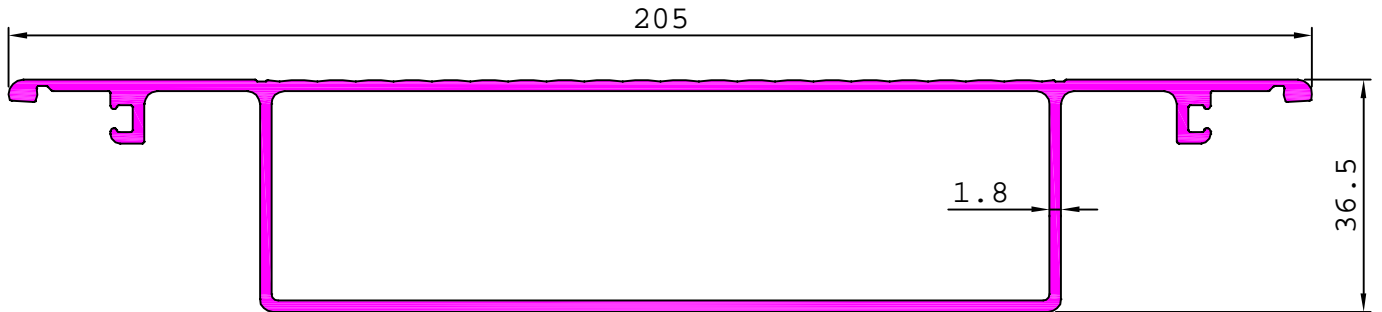

25833

1.554 kg/m

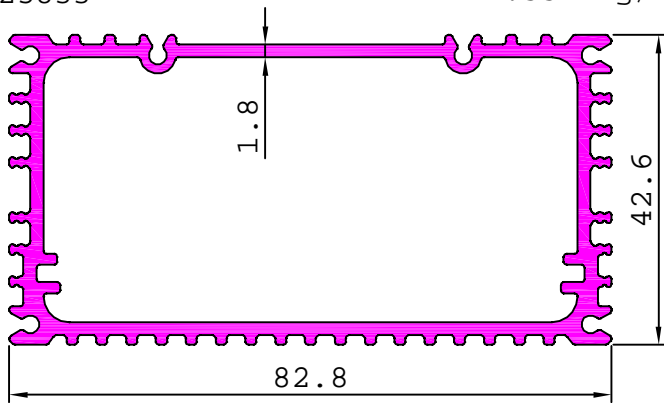

28171

3.468 kg/m

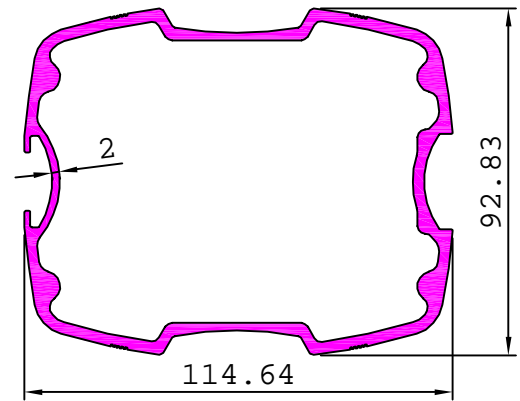

33645

1.773 kg/m

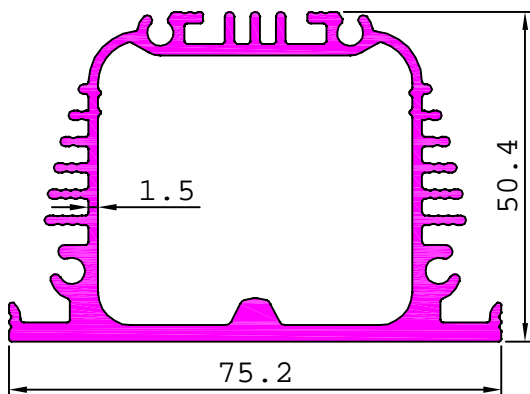

25835

1.448 kg/m

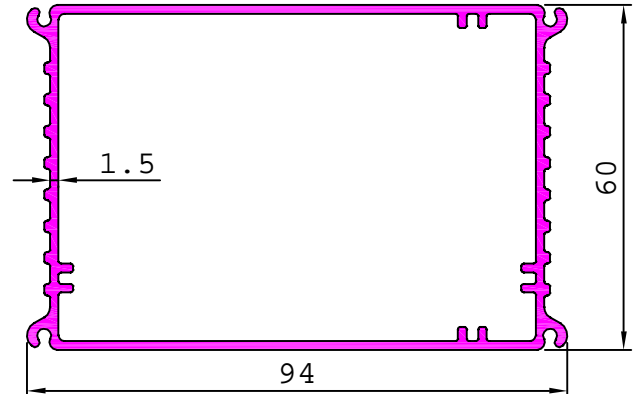

ELECTRONICS

25839

1.228 kg/m

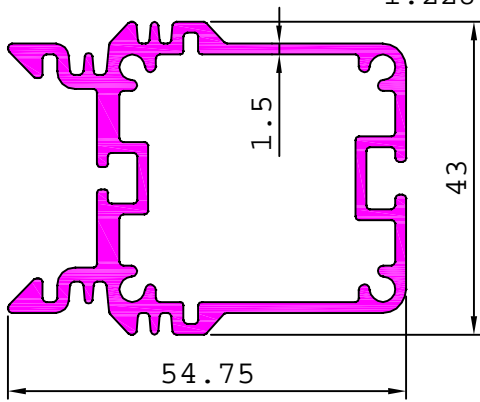

25836

2.546 kg/m

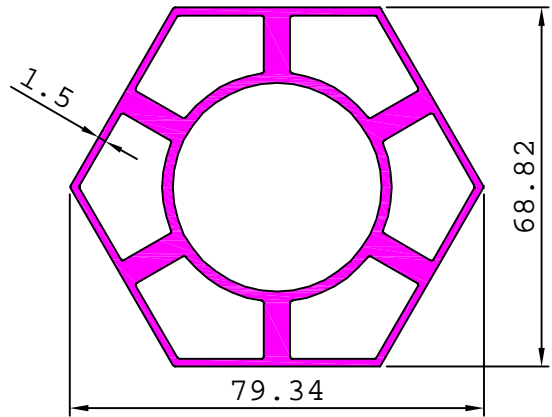

25824

7.643 kg/m

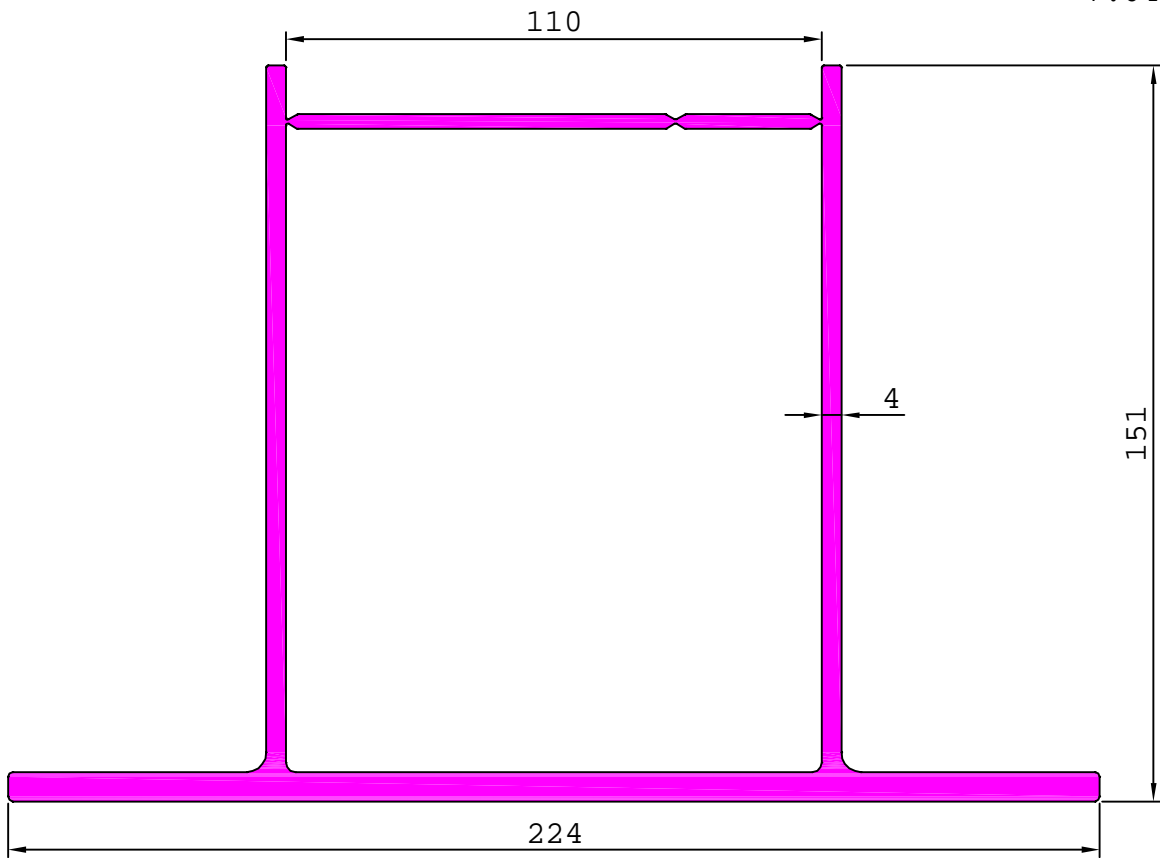

## ELECTRONICS

25821

1.218 kg/m

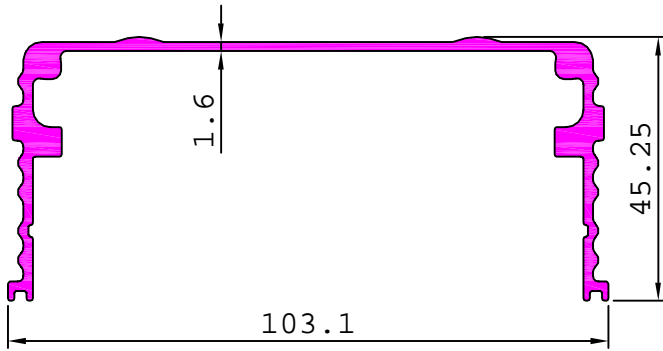

MATCHING WITH 25820

25820

1.043 kg/m

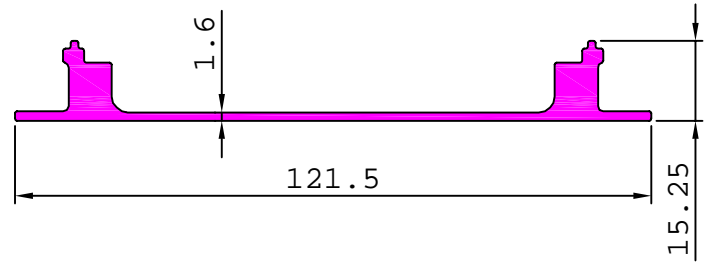

MATCHING WITH 25821

25822

2.065 kg/m

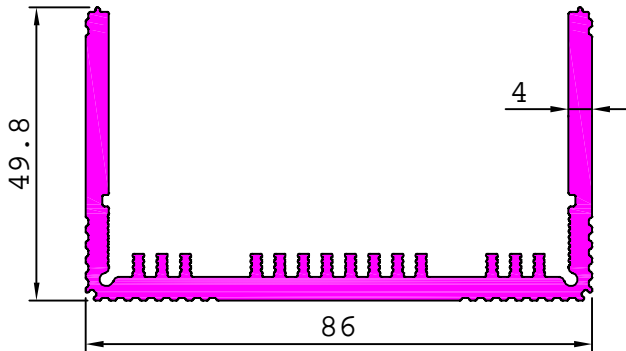

MATCHING WITH 25823

25823

0.644 kg/m

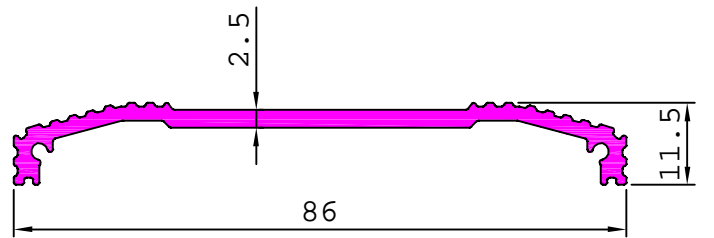

MATCHING WITH 25822

25837

1.234 kg/m

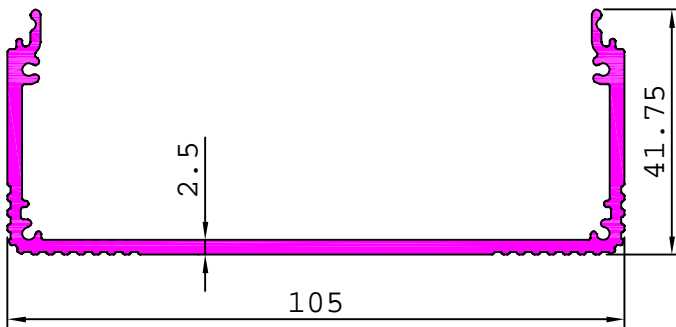

MATCHING WITH S4849

25838

0.924 kg/m

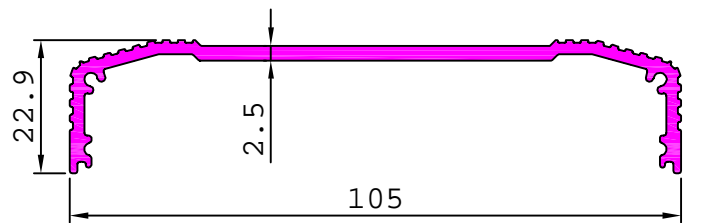

MATCHING WITH S4848

25416

0.741 kg/m

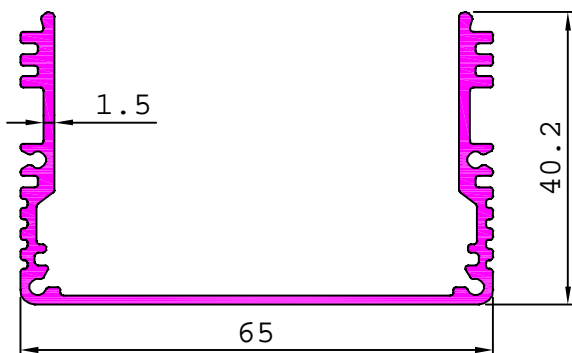

MATCHING WITH 25417

25417

0.282 kg/m

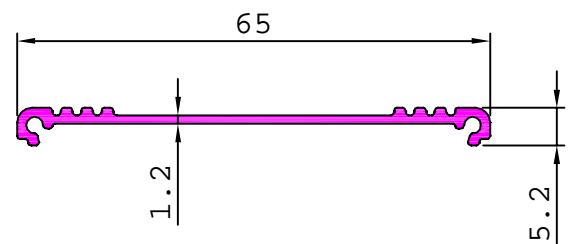

MATCHING WITH 25416

**ELECTRONICS**

25803

7.957 kg/m

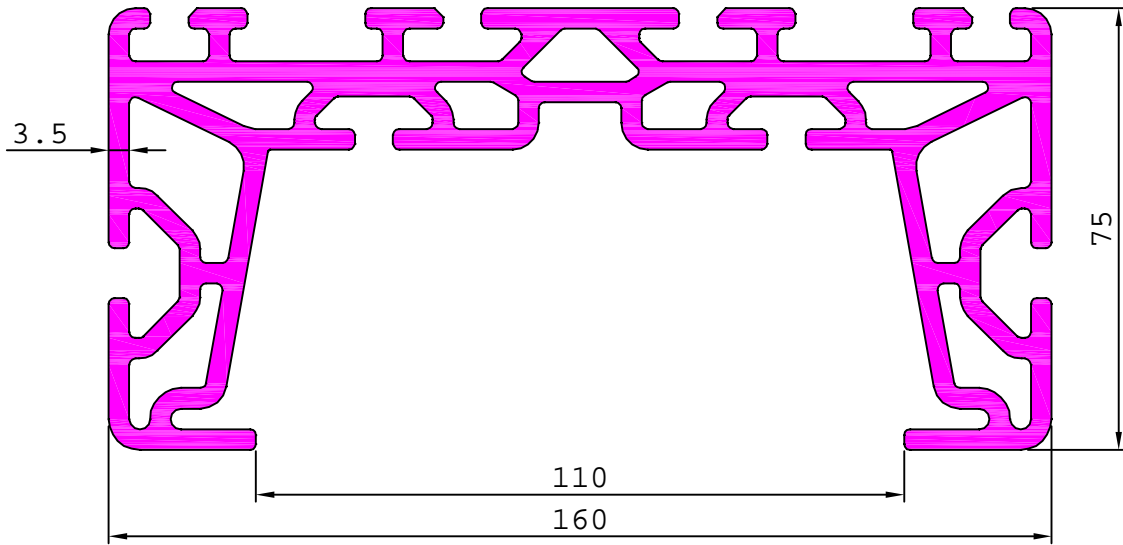

S6308

7.911 kg/m

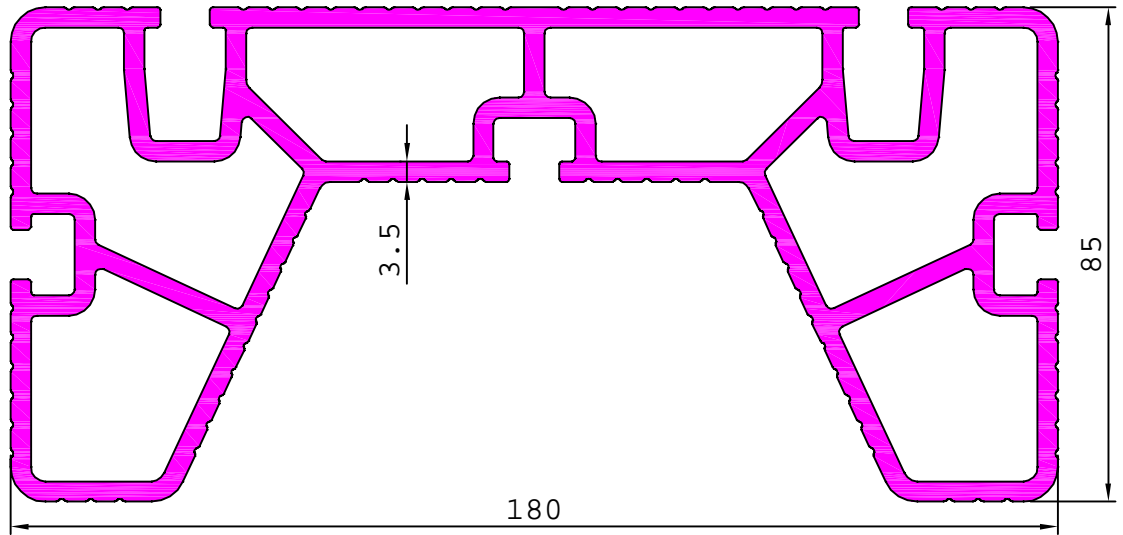

ELECTRONICS

25708

0.353 kg/m

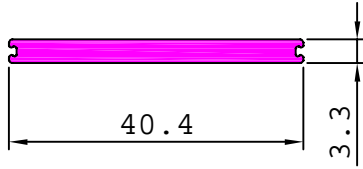

25760

0.634 kg/m

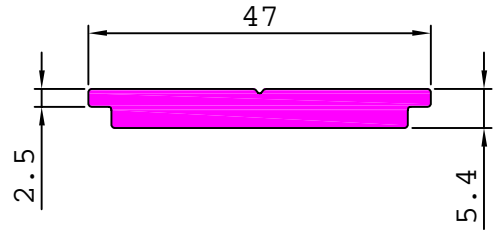

28196

1.448 kg/m

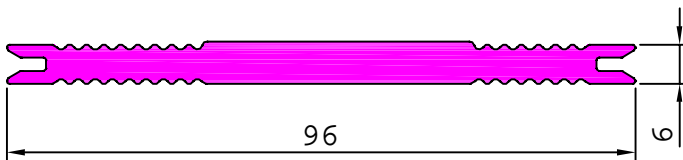

25840

1.017 kg/m

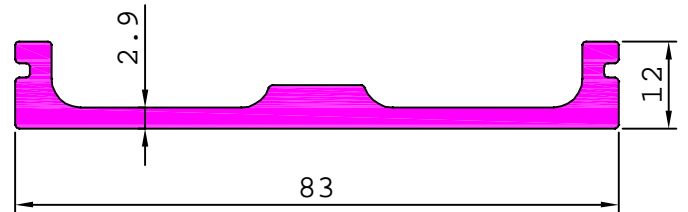

25831

1.637 kg/m

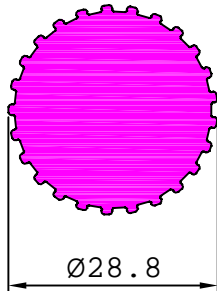

25832

1.429 kg/m

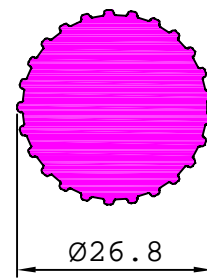

ELECTRONICS

25725

2.239 kg/m

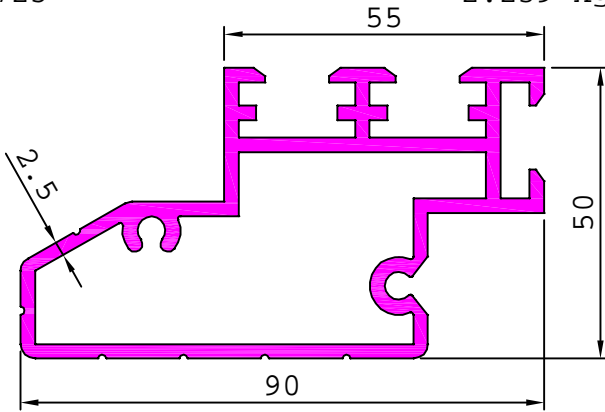

25754

2.178 kg/m

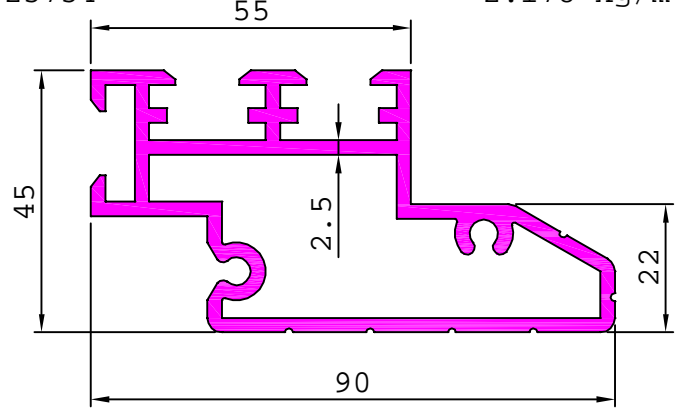

25788

1.359 kg/m

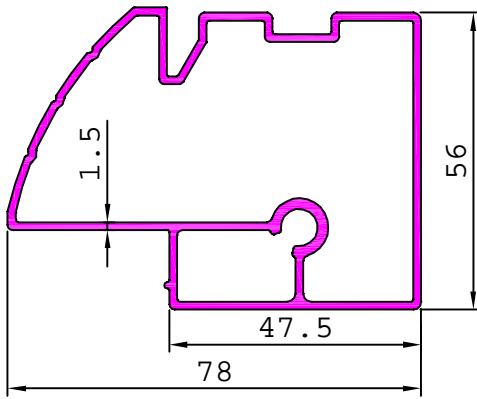

25789

1.157 kg/m

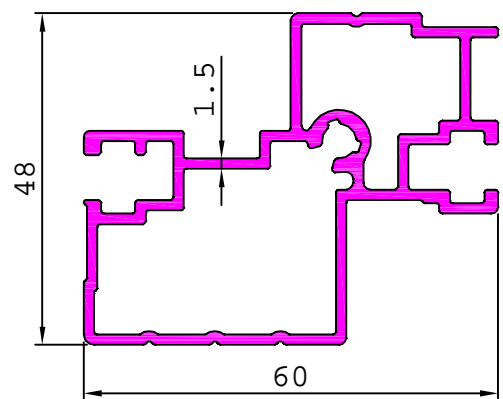

25732

1.594 kg/m

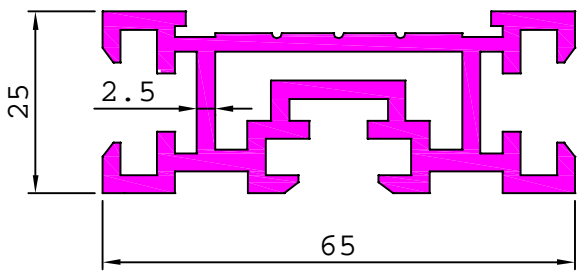

**ELECTRONICS**

25790

2.034 kg/m

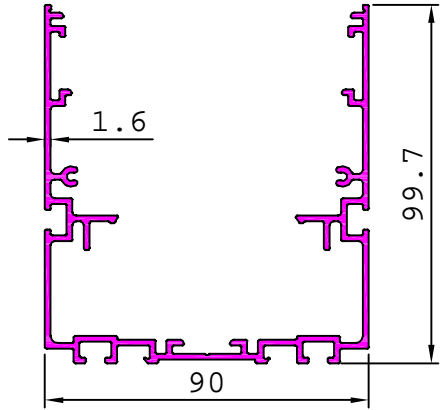

25791

110.3

2.148 kg/m

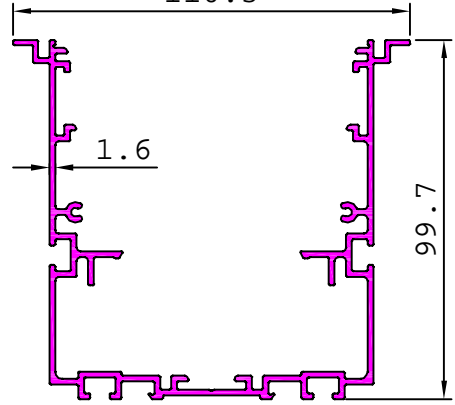

25801

1.681 kg/m

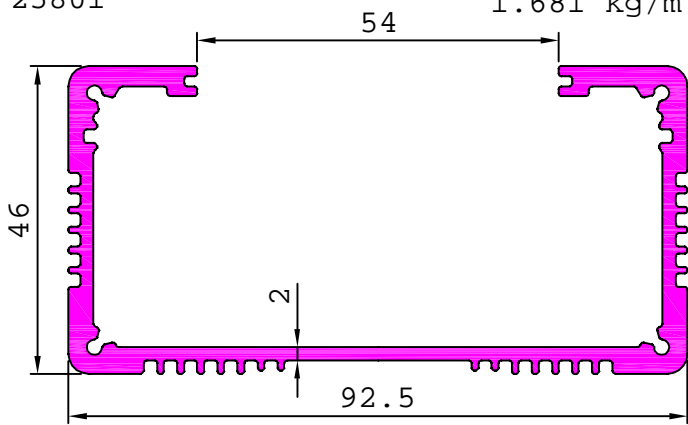

**ELECTRONICS**

25800

1.998 kg/m

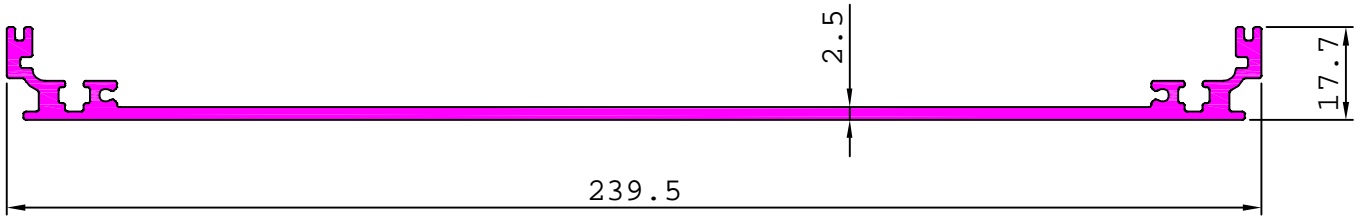

25810

8.468 kg/m

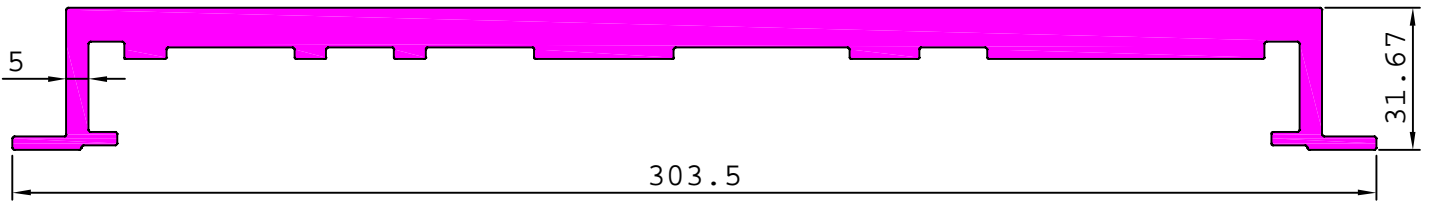

25825

2.559 kg/m

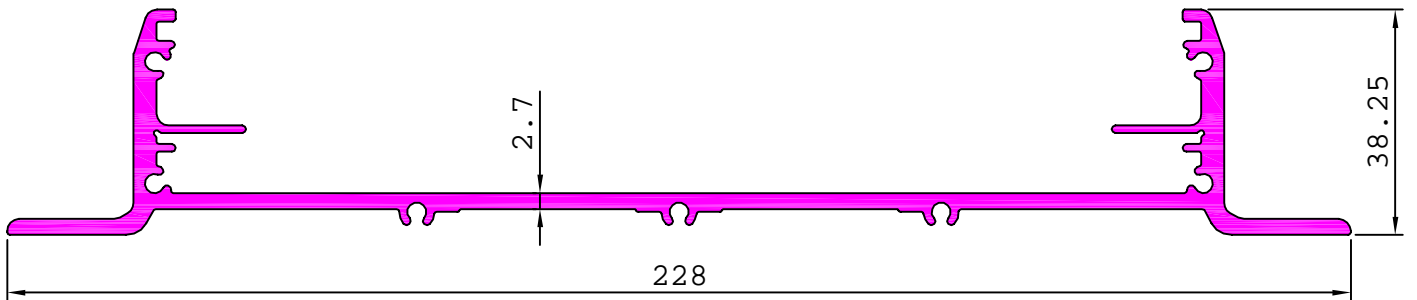



ELECTRONICS

28353

1.671 kg/m

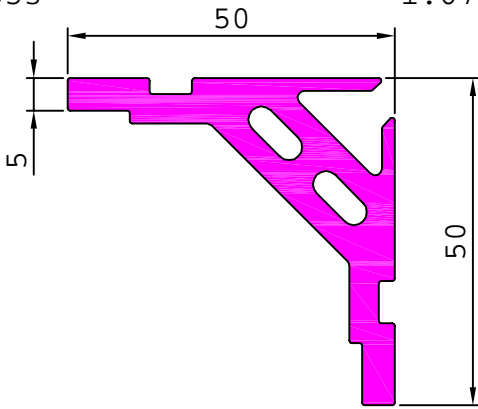

25795

0.942 kg/m

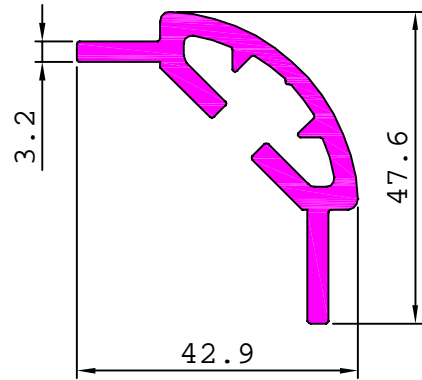

S6130

1.170 kg/m

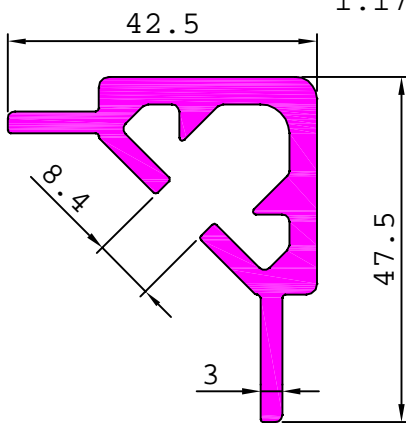

ELECTRONICS

25798

23.035 kg/m

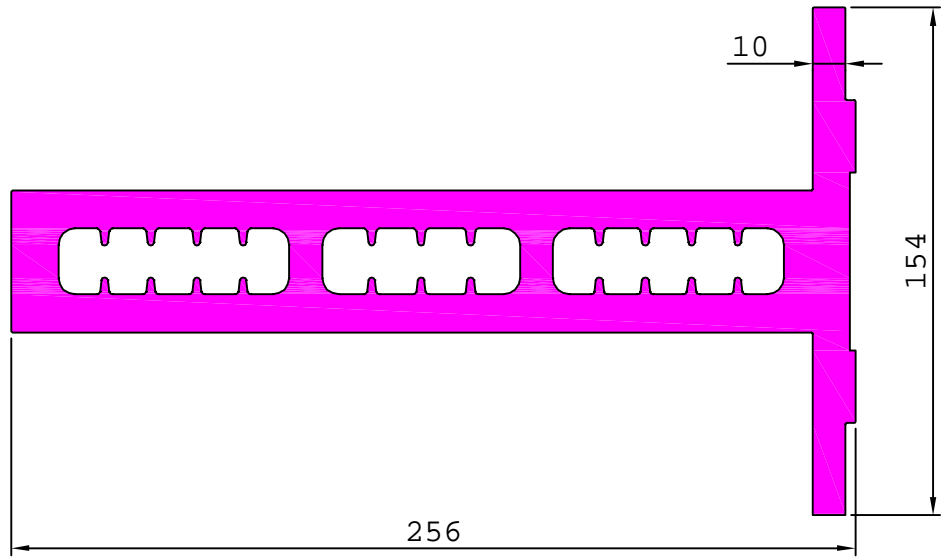

G027882

31.297 kg/m

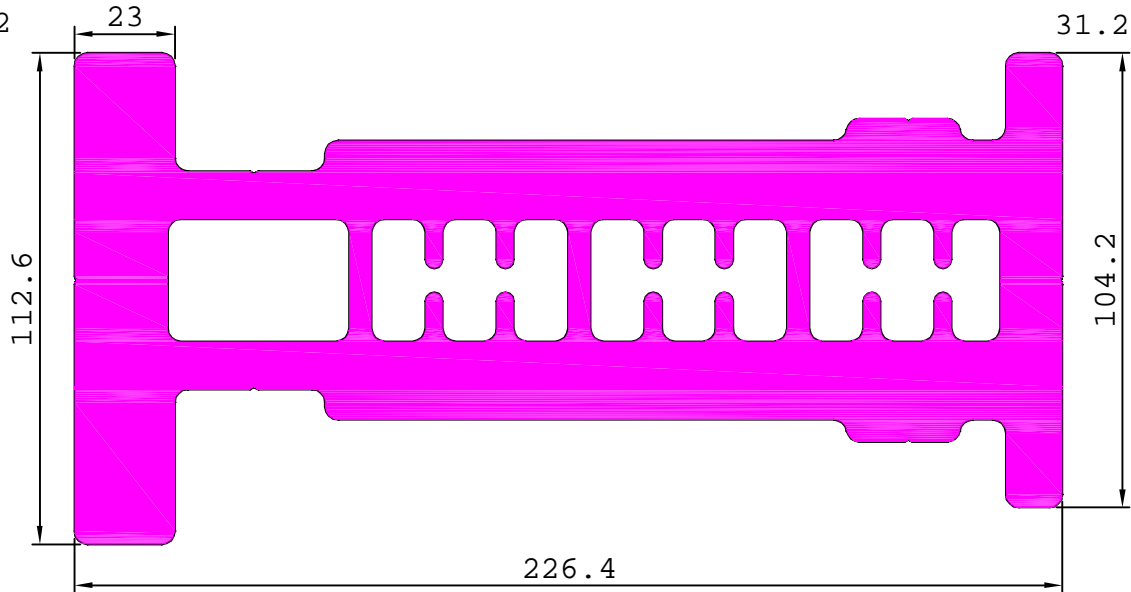

27902

23.855 kg/m

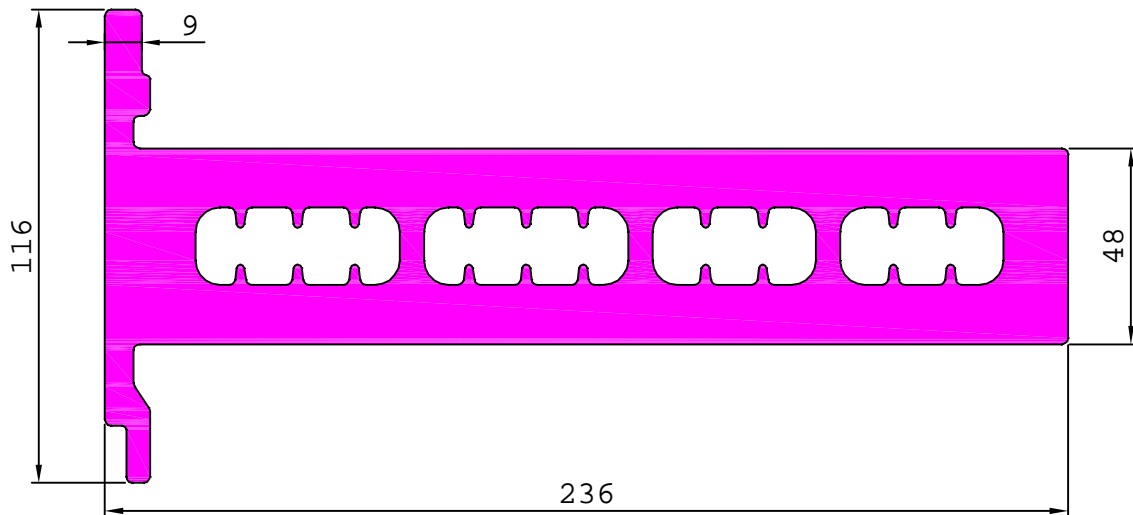

**ELECTRONICS**

25829

31.803 kg/m

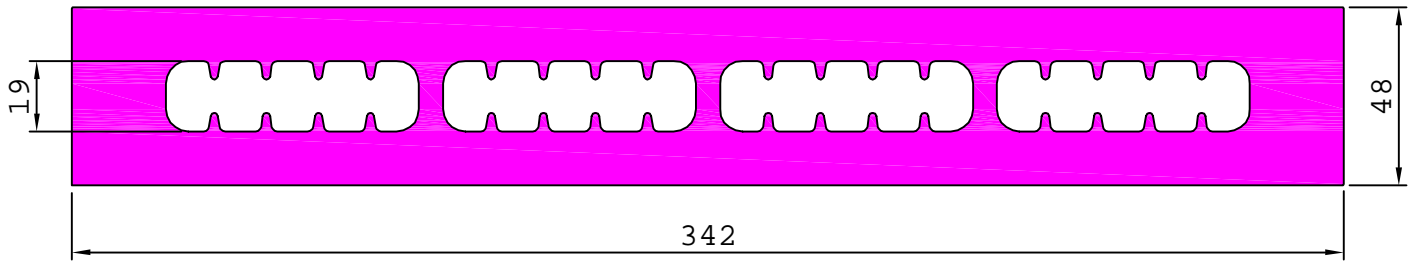

G100863

5.969 kg/m

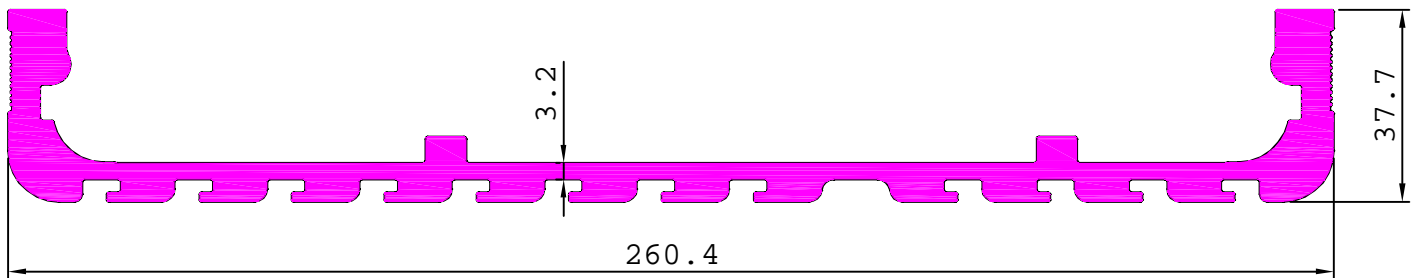

**MATCHING WITH G100864**

G100864

3.623 kg/m

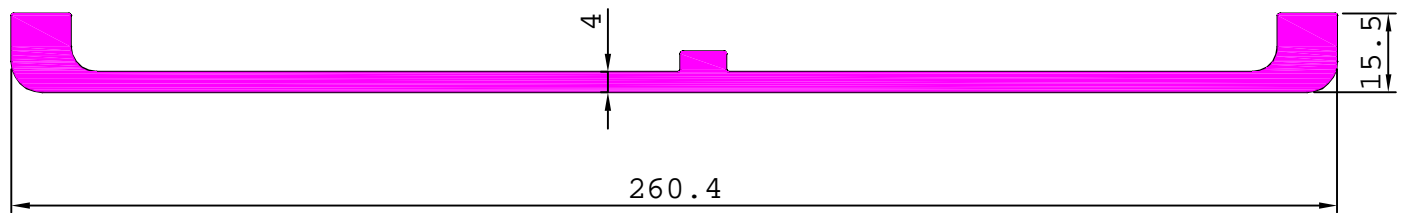

**MATCHING WITH G100863**

**ELECTRONICS**

25705

2.286 kg/m

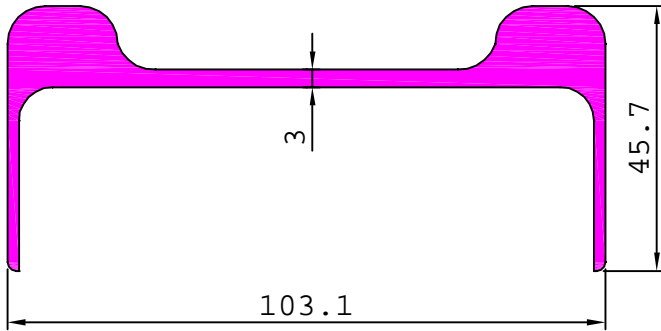

25730

0.365 kg/m

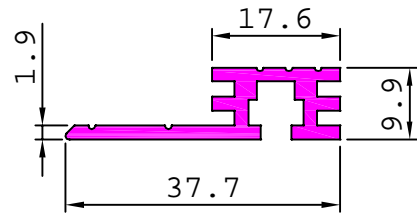

25713

1.660 kg/m

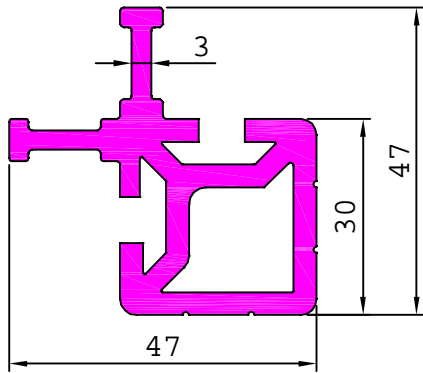

25767

2.100 kg/m

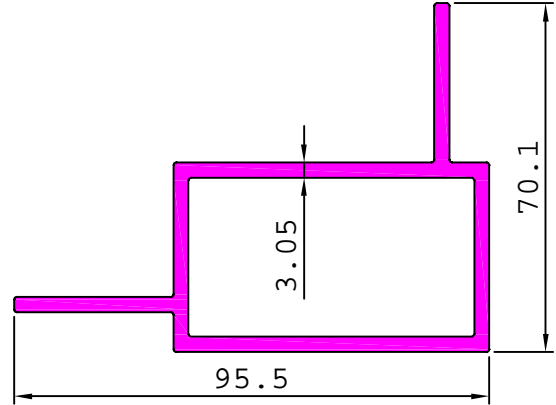

25717

1.316 kg/m

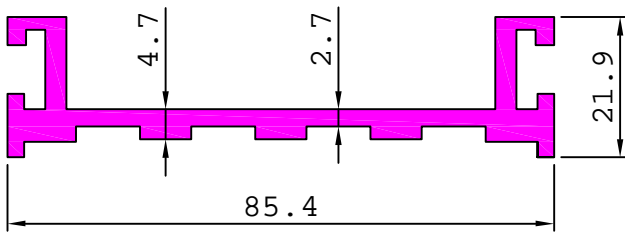

25720

0.468 kg/m

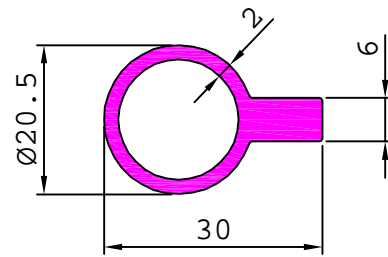

25792

0.414 kg/m

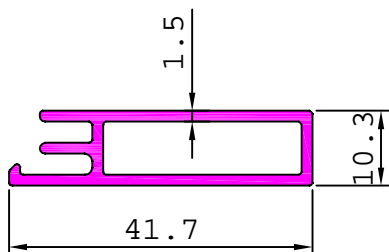

26407

2.224 kg/m

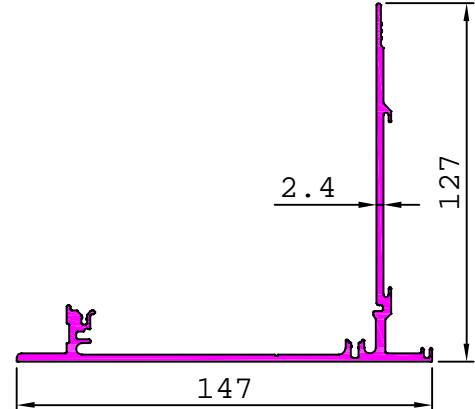

**ELECTRONICS**

25815

0.326 kg/m

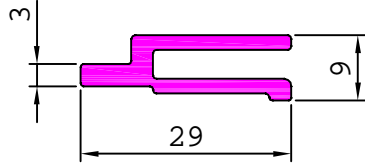

25781

0.215 kg/m

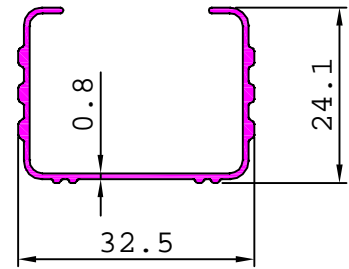

25826

0.471 kg/m

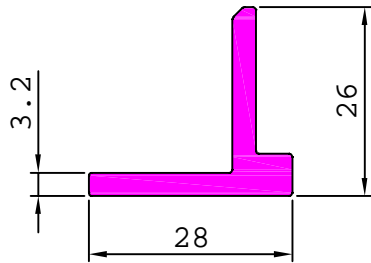

25737

0.401 kg/m

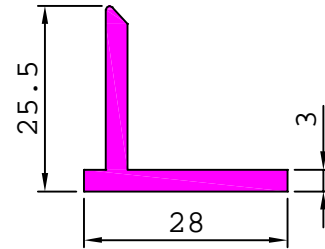

25799

0.373 kg/m

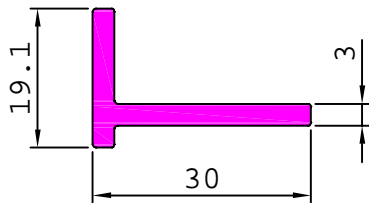

25814

2.484 kg/m

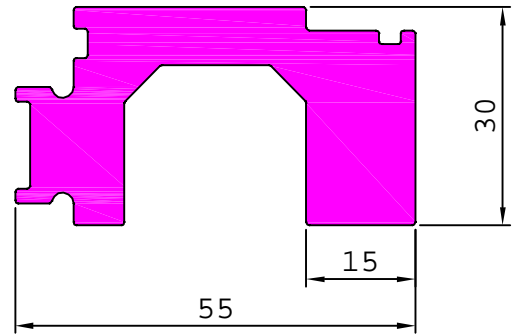

25807

1.860 kg/m

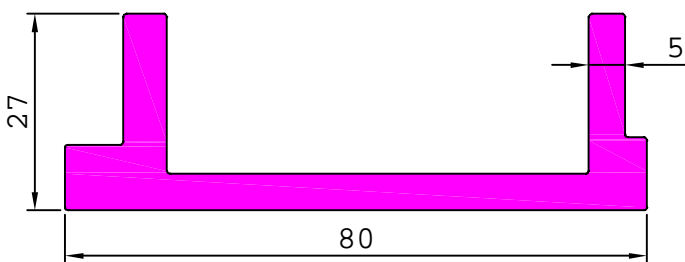

S6166

0.290 kg/m

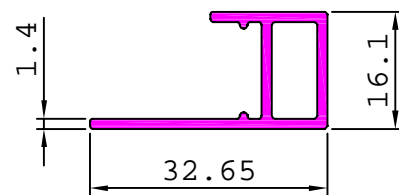

ELECTRONICS

25842

0.311 kg/m

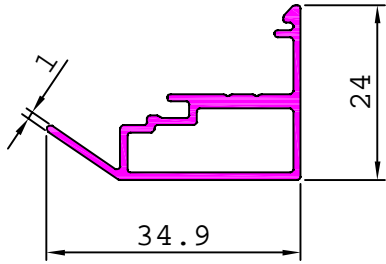

25843

0.592 kg/m

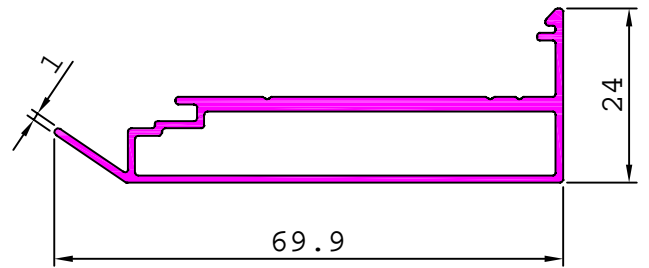

S6819

0.227 kg/m

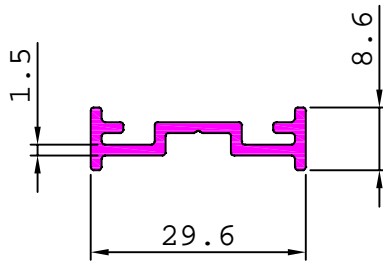

25850

1.087 kg/m

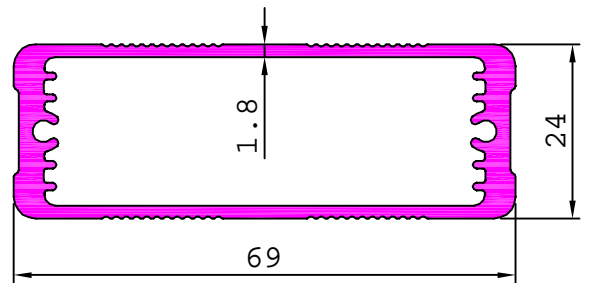

G100612

2.028 kg/m

