

## LADDERS

### FLUTED ROUND TUBES

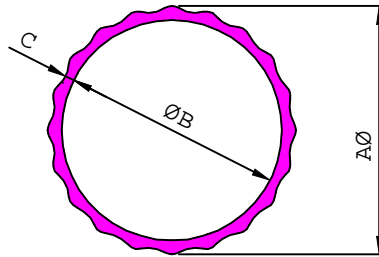

SL. No.	Section No.	ØA	ØB	C	Weight kg/m
1	<b>14904</b>	18.50	16.75	0.67	0.114
2	<b>14907</b>	18.50	17.33	0.38	0.074
3	<b>14913</b>	18.80	16.70	0.70	0.127
4	<b>14901</b>	19.05	16.90	0.70	0.130
5	<b>14910</b>	20.50	17.70	0.90	0.186
6	<b>14909</b>	20.70	19.20	0.52	0.109
7	<b>14915</b>	24.00	22.62	0.49	0.114
8	<b>14903</b>	24.80	22.60	0.70	0.179
9	<b>14916</b>	24.80	22.97	0.67	0.156
10	<b>14906</b>	24.80	23.56	0.416	0.107
11	<b>14921</b>	24.80	22.84	0.58	0.148
12	<b>14902</b>	25.40	20.34	1.83	0.410
13	<b>14914</b>	25.40	22.01	0.93	0.252
14	<b>14912</b>	25.40	22.07	0.90	0.247
15	<b>14908</b>	25.40	22.20	0.79	0.226
16	<b>14917</b>	25.40	22.68	0.60	0.189
17	<b>14919</b>	25.40	20.80	1.60	0.370
18	<b>14905</b>	28.00	25.50	0.80	0.237
19	<b>14911</b>	28.00	26.32	0.63	0.171
20	<b>14918</b>	32.06	27.00	1.83	0.533
21	<b>14920</b>	37.00	33.00	1.50	0.511

## LADDERS

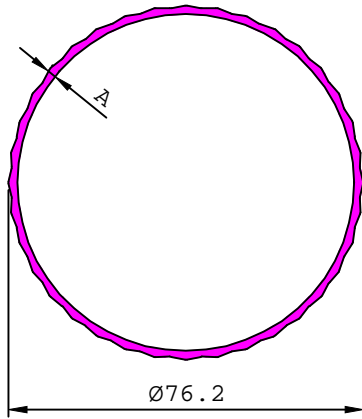

SL. No.	Section No.	A	Weight kg/m
1	<b>22592</b>	1.60	0.839
2	<b>22585</b>	1.90	1.024

22597

0.978 kg/m

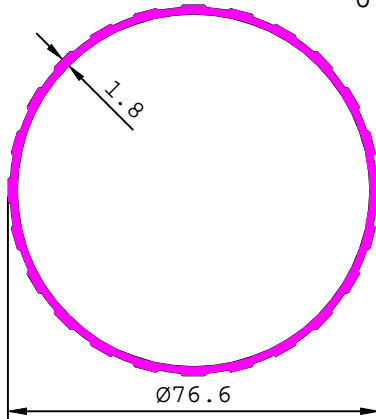

14922

0.560 kg/m

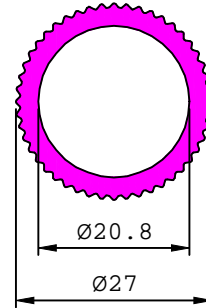

22576

0.441 kg/m

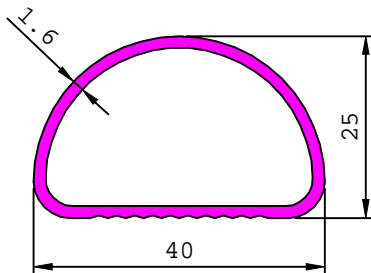

22522

0.536 kg/m

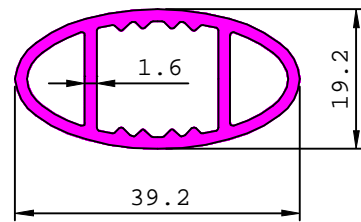

## LADDERS

22577

0.263 kg/m

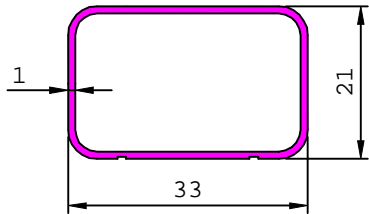

22578

0.349 kg/m

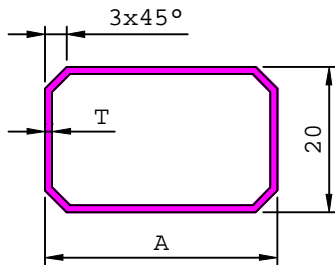
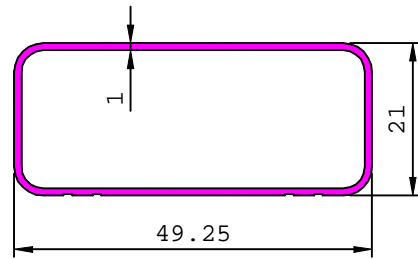

SL. No.	Section No.	A	T	Weight kg/m
1	<b>22502</b>	32.00	1.00	0.252
2	<b>42006</b>	33.00	1.50	0.381
3	<b>22501</b>	50.00	1.00	0.350
4	<b>42005</b>	50.00	1.50	0.518

38577

0.448 kg/m

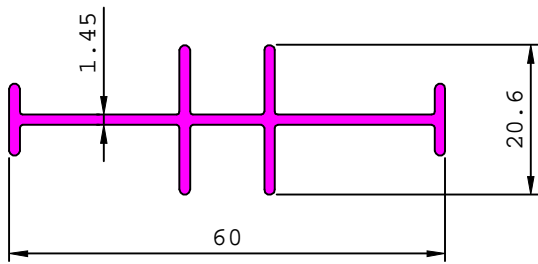

42002

0.533 kg/m

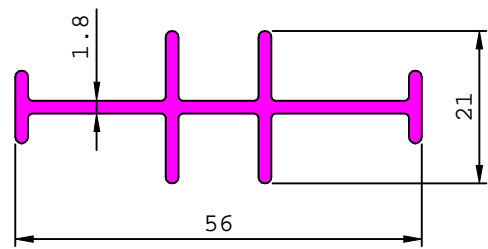

## LADDERS

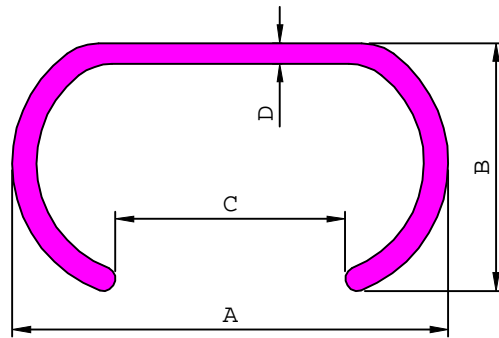

SL. No.	Section No.	A	B	C	D	Weight kg/m
1	<b>22552</b>	62.00	28.00	40.00	1.10	0.335
2	<b>22544</b>	66.65	31.75	41.30	1.20	0.410
3	<b>22511</b>	66.65	31.75	41.30	1.81	0.607
4	<b>22571</b>	66.65	31.75	41.30	2.20	0.732
5	<b>22503</b>	66.65	31.75	41.30	2.54	0.837
6	<b>22504</b>	66.67	31.75	41.27	3.18	1.046
7	<b>22505</b>	66.68	31.75	47.00	4.00	1.247
8	<b>42003</b>	66.00	31.50	40.20	2.50	0.829

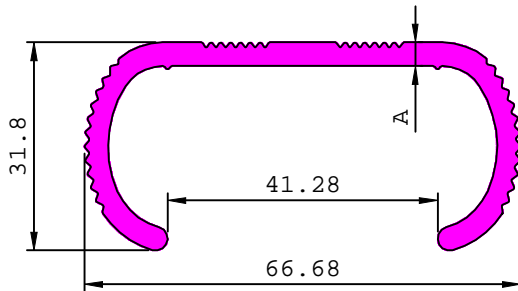

SL. No.	Section No.	A	Weight kg/m
1	<b>22583</b>	3.20	0.985
2	<b>22575</b>	3.60	1.105

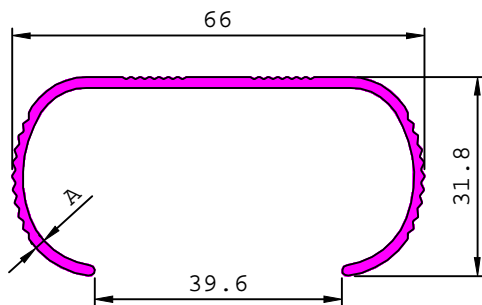

SL. No.	Section No.	A	Weight kg/m
1	<b>22573</b>	1.70	0.544
2	<b>22574</b>	2.50	0.800

## LADDERS

22513

0.976 kg/m

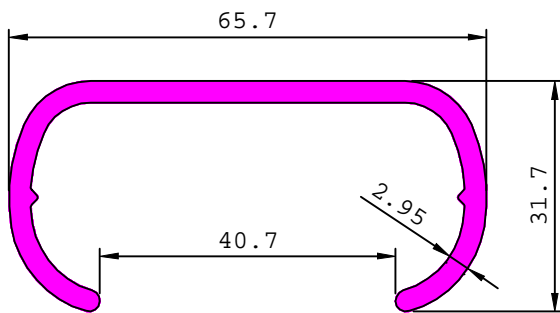

22516

1.009 kg/m

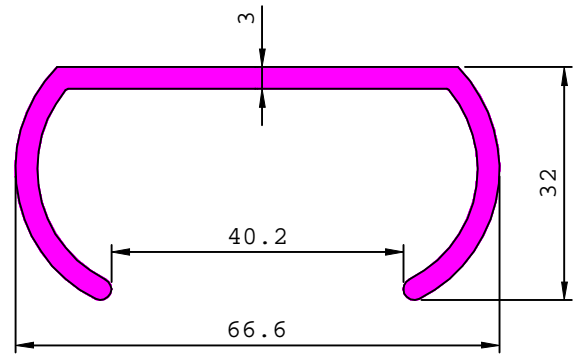

22524

0.668 kg/m

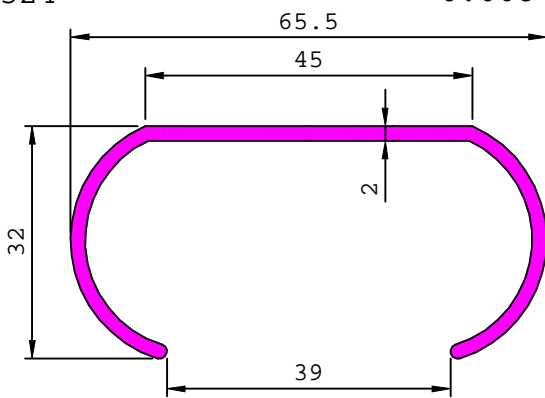

42001

0.770 kg/m

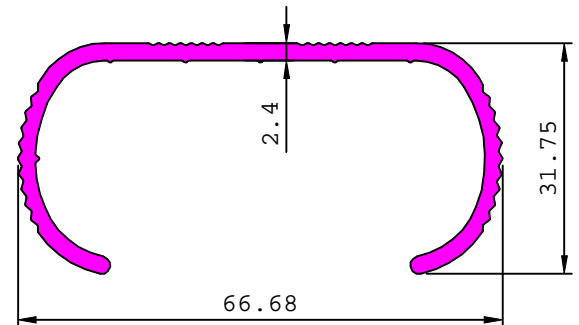

22559

0.345 kg/m

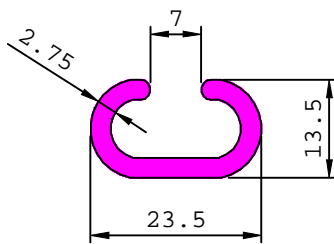

## LADDERS

22510

0.775 kg/m

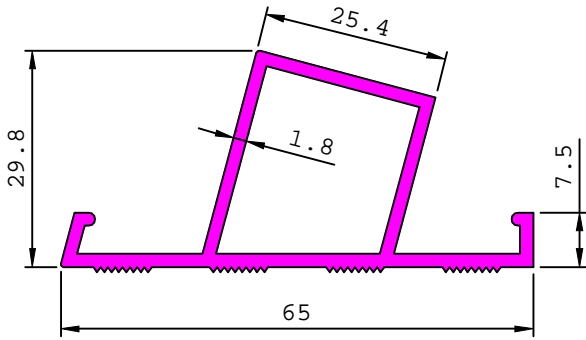

22520

1.038 kg/m

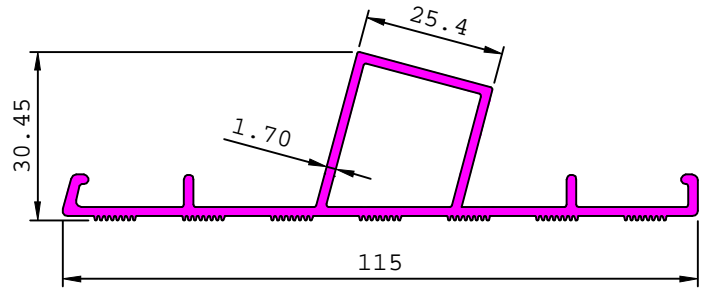

22562

0.516 kg/m

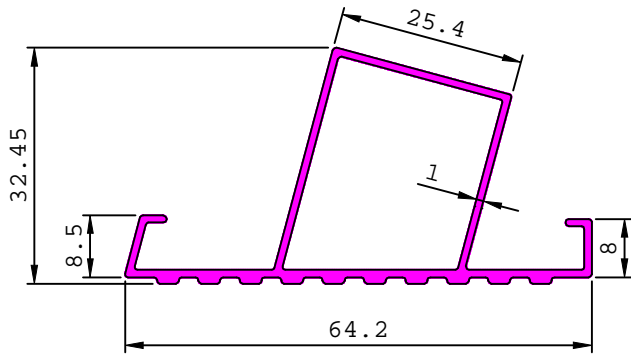

22566

0.692 kg/m

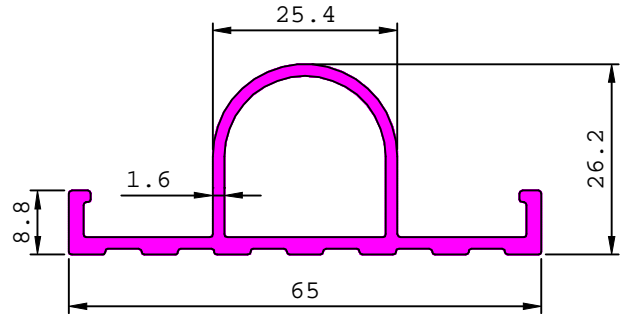

22582

0.510 kg/m

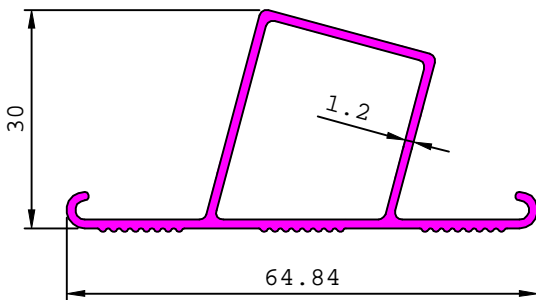

22595

0.476 kg/m

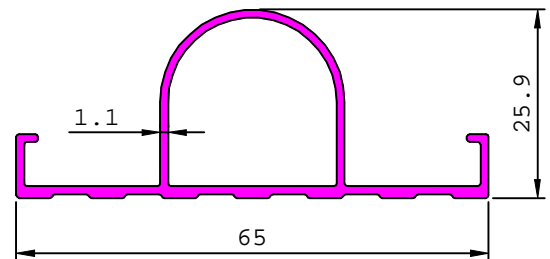

G100551

0.447 kg/m

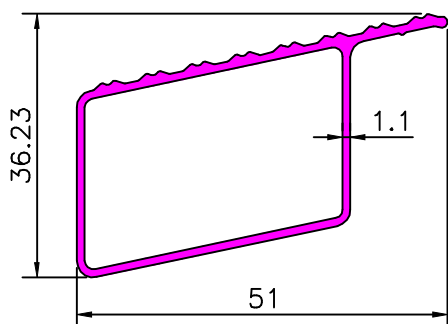

## LADDERS

22515

0.535 kg/m

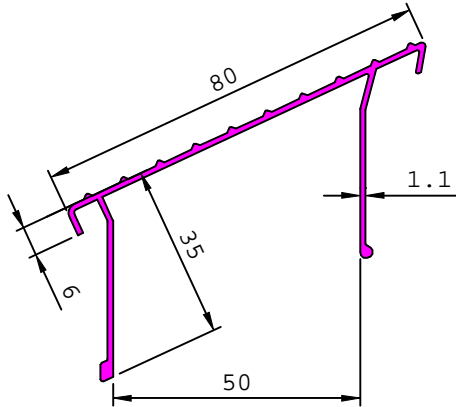

22526

0.506 kg/m

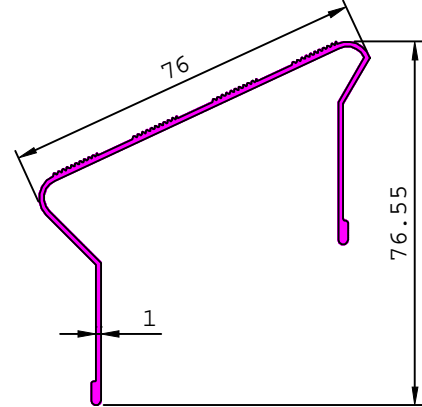

22525

0.486 kg/m

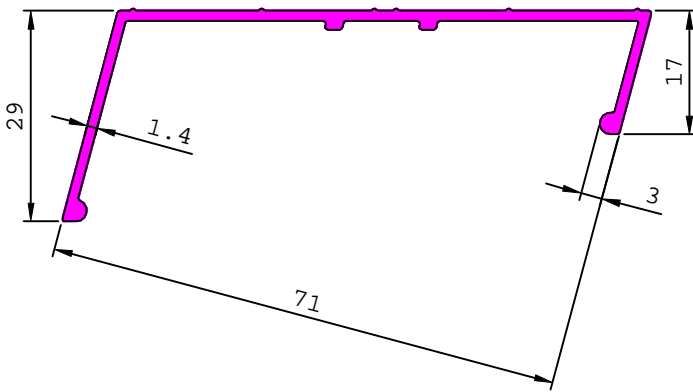

22547

0.875 kg/m

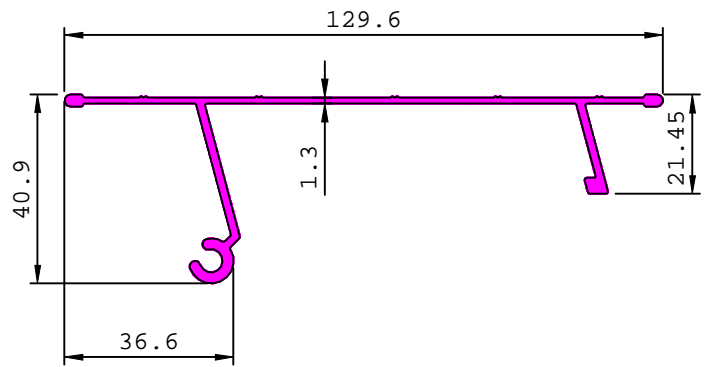

MATCHING WITH 22546

22550

1.296 kg/m

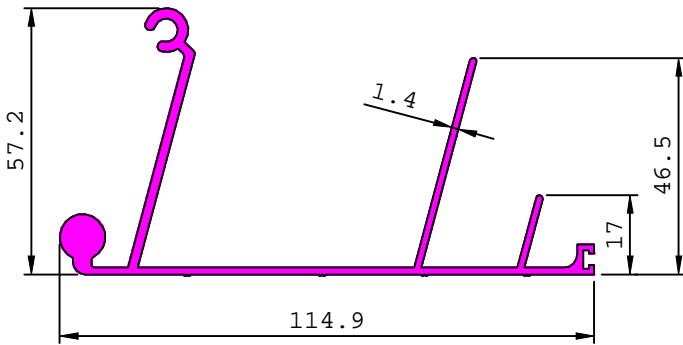

22551

1.103 kg/m

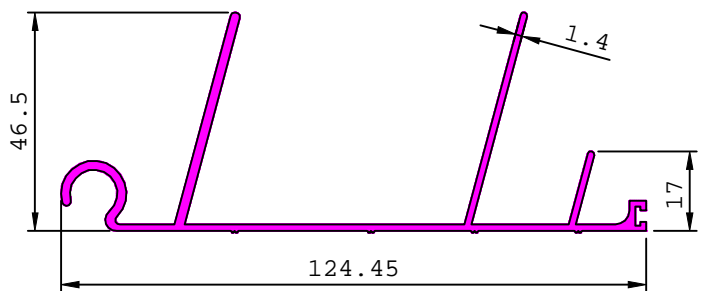

22553

0.287 kg/m

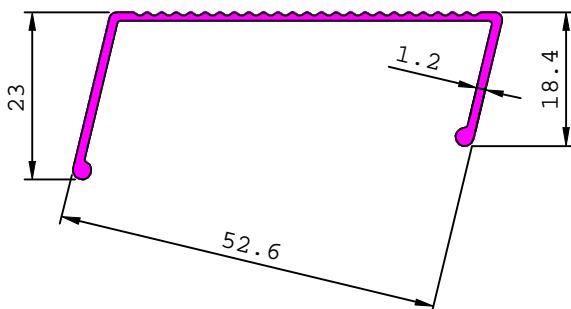

22565

0.328 kg/m

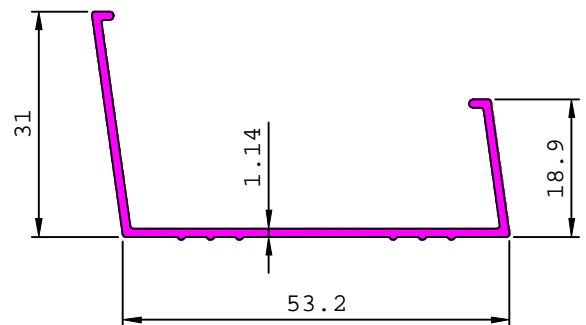

## LADDERS

22568

0.594 kg/m

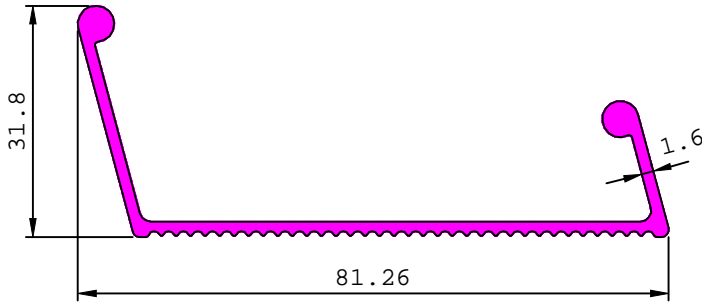

22570

0.609 kg/m

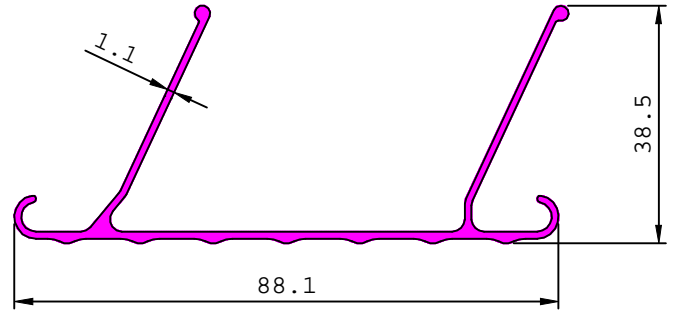

22558

0.777 kg/m

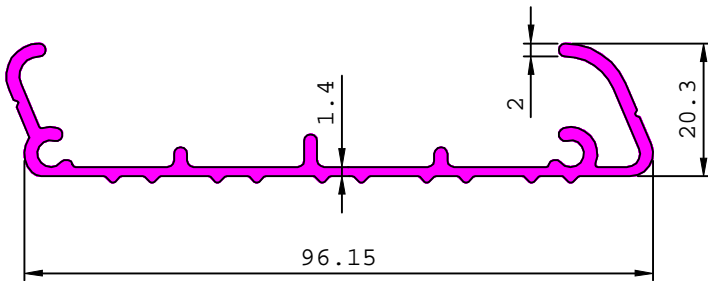

22507

0.673 kg/m

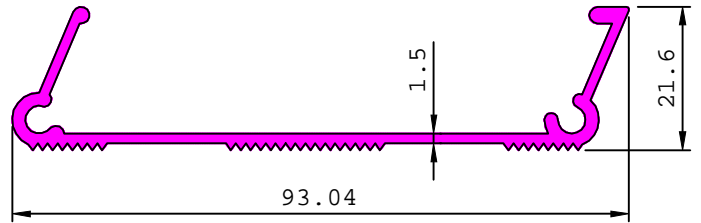

22581

0.404 kg/m

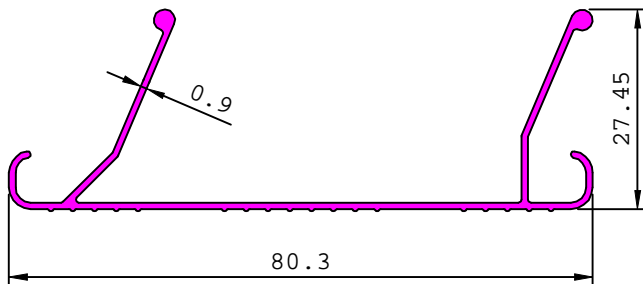

22588

0.681 kg/m

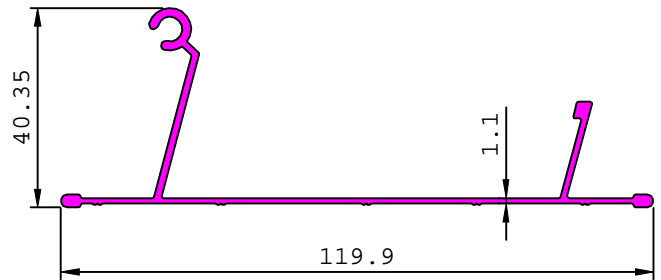

MATCHING WITH 22590

42004

0.700 kg/m

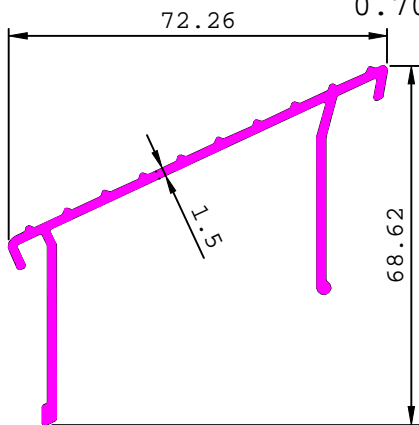

G100094

0.539 kg/m

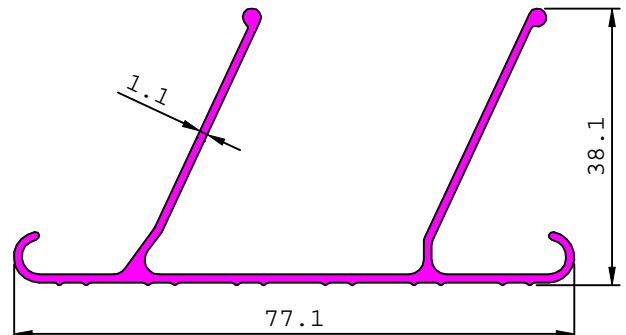



## LADDERS

22587

0.415 kg/m

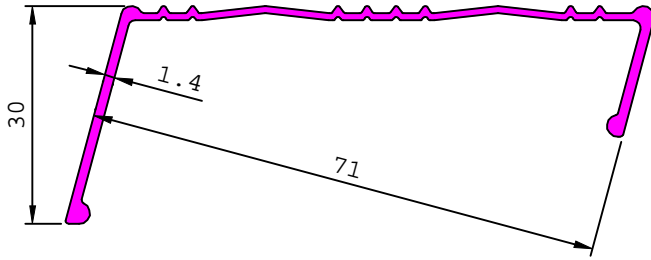

22589

0.398 kg/m

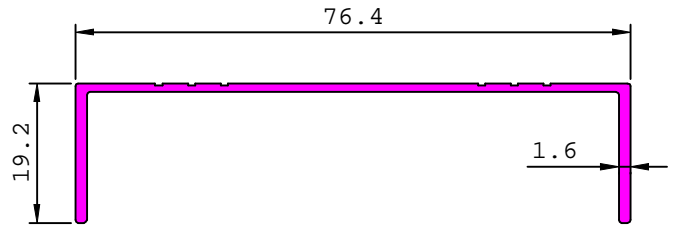

22593

0.816 kg/m

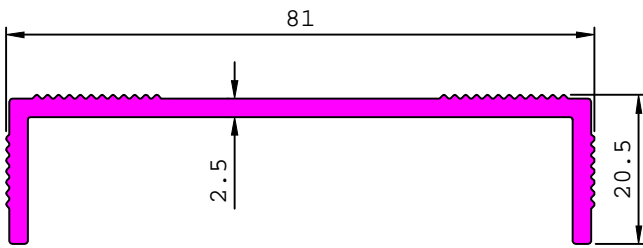

22508

0.662 kg/m

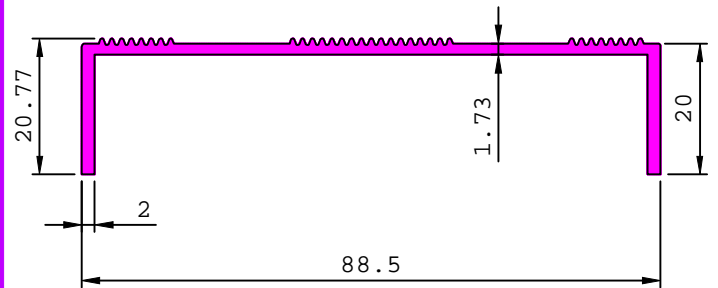

22512

0.575 kg/m

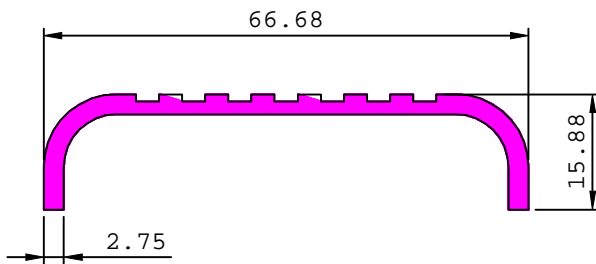

22548

0.355 kg/m

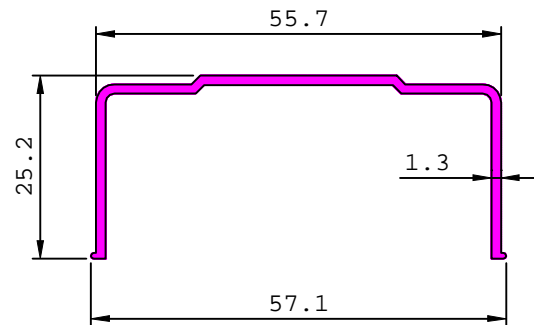

22563

0.327 kg/m

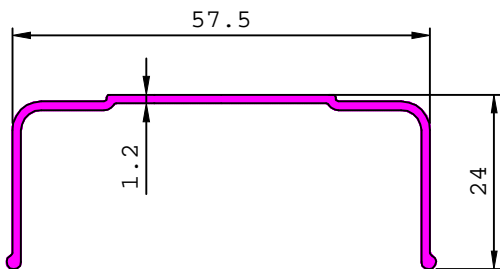

22567

0.640 kg/m

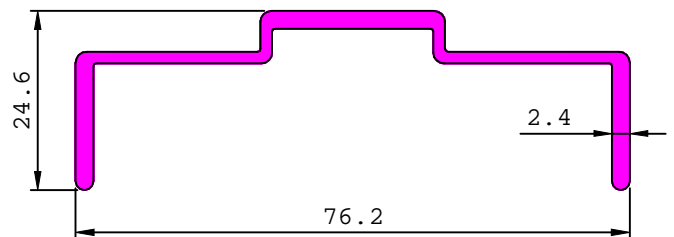

## LADDERS

22584

0.793 kg/m

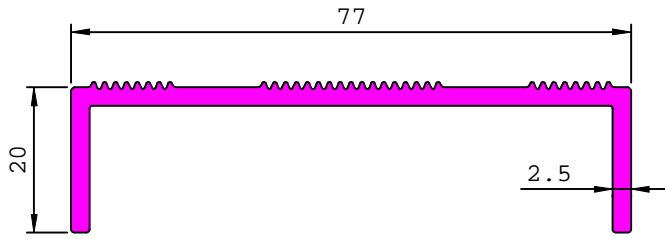

22519

0.659 kg/m

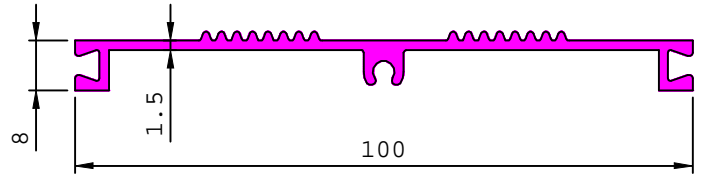

22579

0.661 kg/m

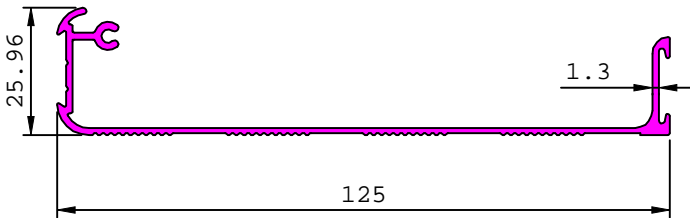

22580

0.666 kg/m

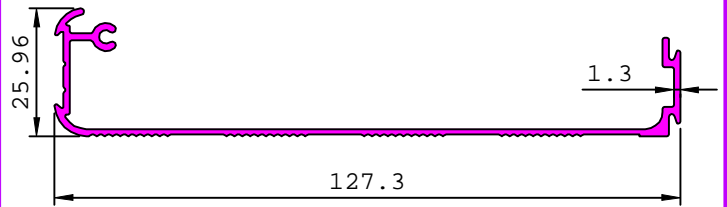

22518

0.871 kg/m

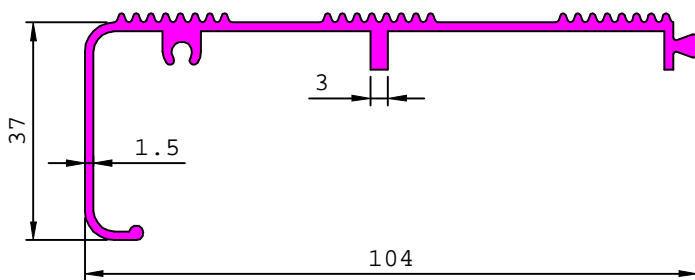

22572

0.739 kg/m

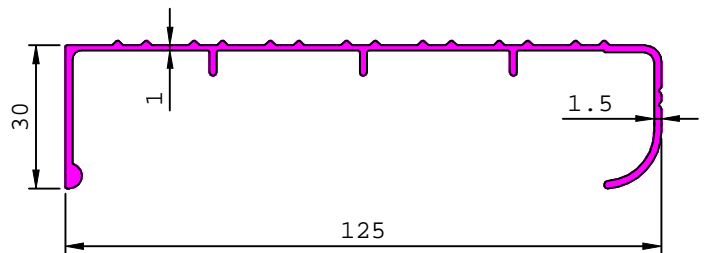

LADDERS

22523

1.099 kg/m

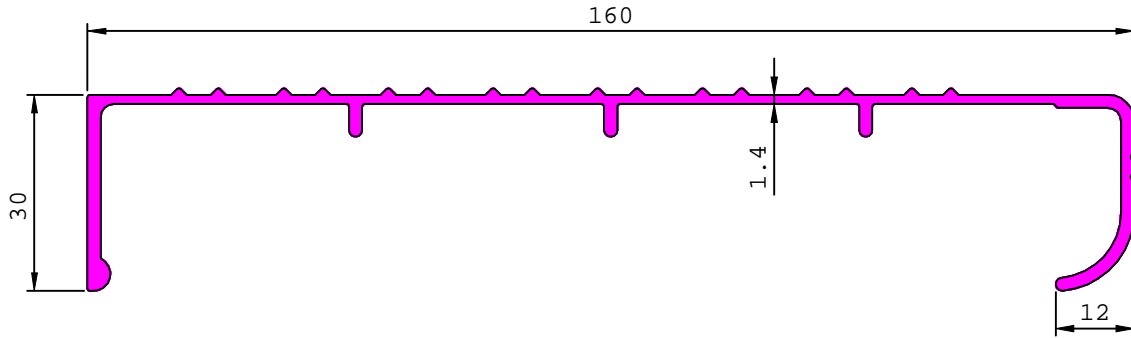

22591

1.538 kg/m

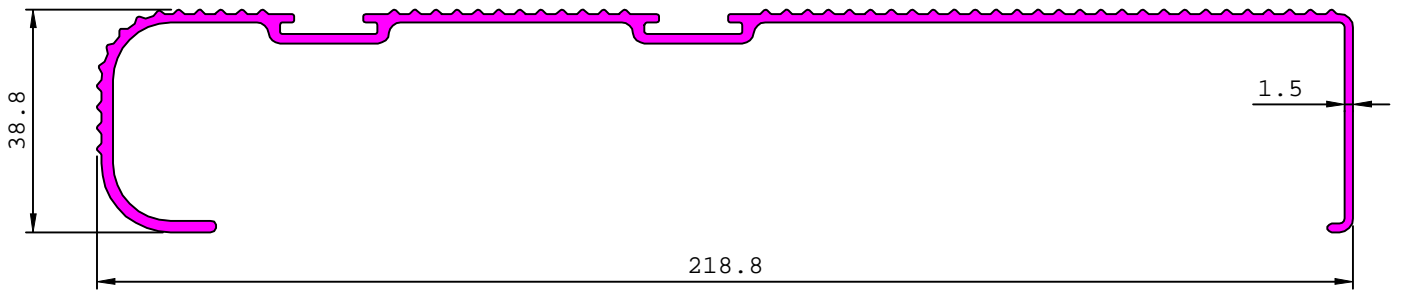

22594

1.551 kg/m

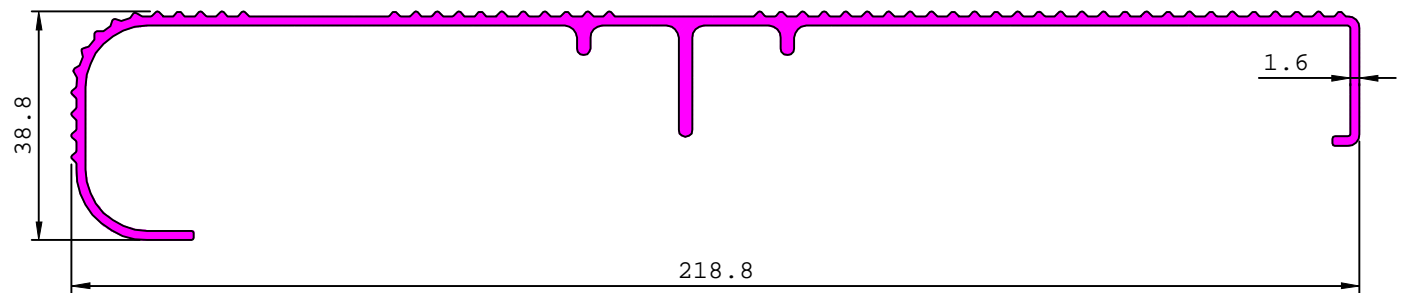

22521

1.251 kg/m

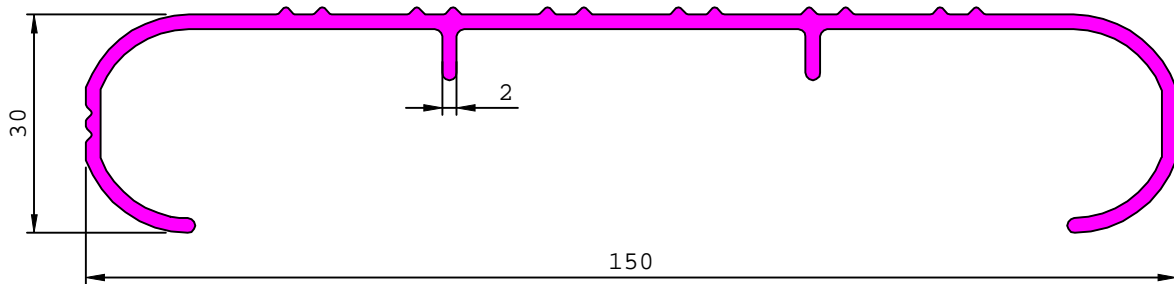

## LADDERS

22546

0.371 kg/m

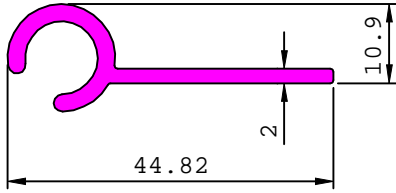

MATCHING WITH 22547

22590

0.271 kg/m

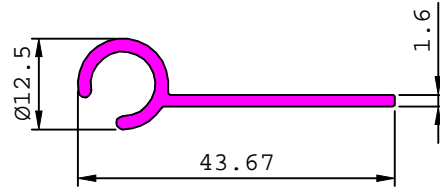

MATCHING WITH 22588

22564

0.133 kg/m

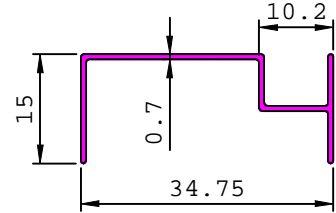

22545

0.197 kg/m

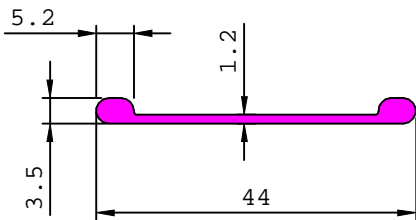

LADDERS

22586

17.378 kg/m

222.31

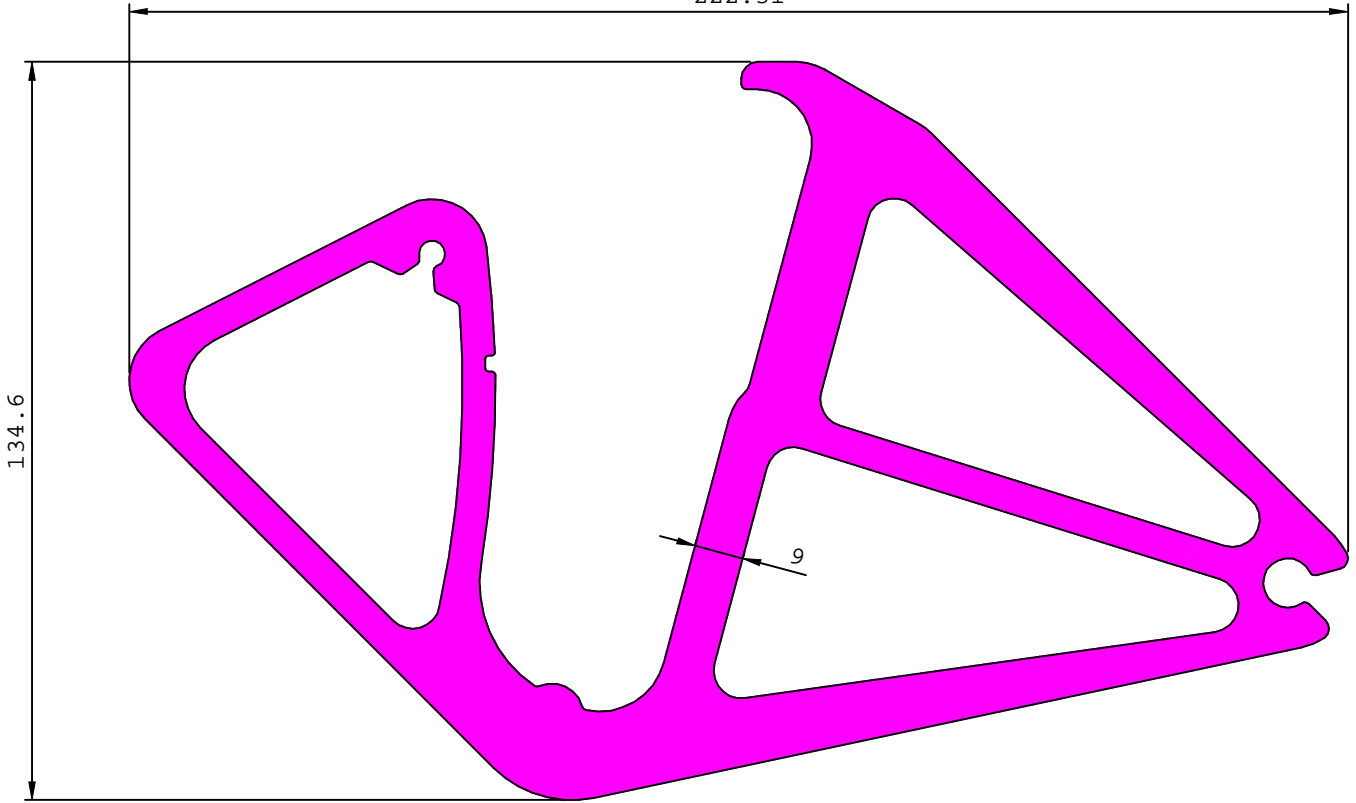

22600

6.504 kg/m

