

**SOLAR POWER SECTION**

26206

0.622 kg/m

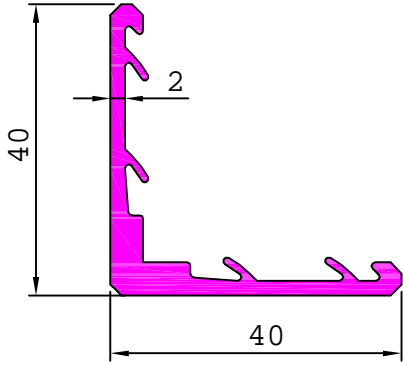

26215

0.365 kg/m

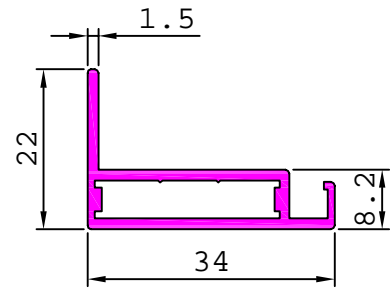

26214

0.261 kg/m

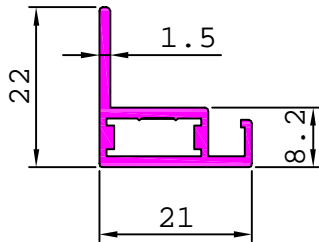

26210

0.578 kg/m

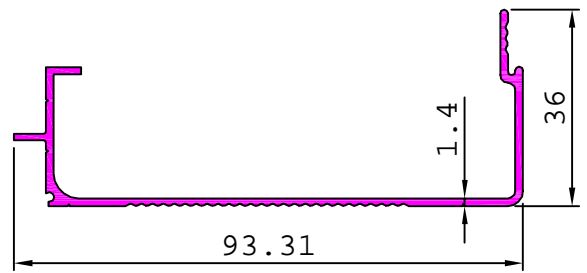

26211

0.688 kg/m

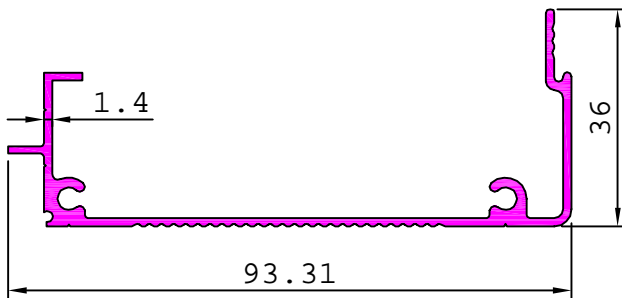

26216

0.941 kg/m

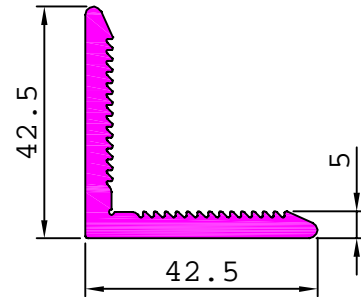

26217

0.552 kg/m

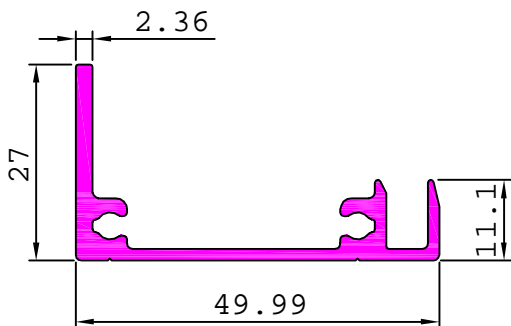

26219

0.285 kg/m

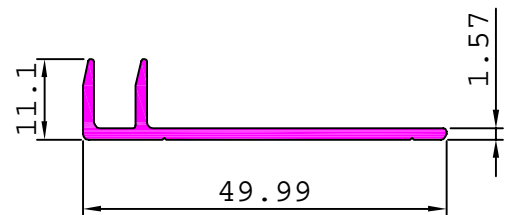

**SOLAR POWER SECTION**

26225

0.829 kg/m

26235

0.494 kg/m

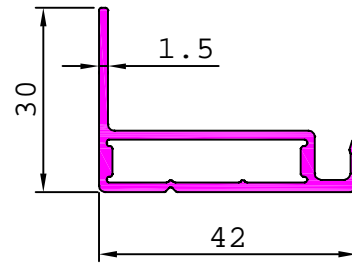
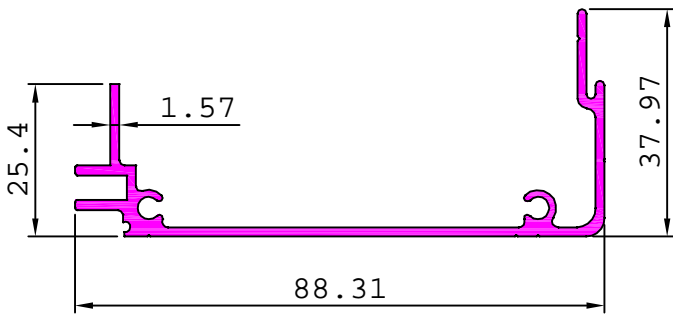

26224

0.141 kg/m

26232

0.111 kg/m

26233

0.163 kg/m

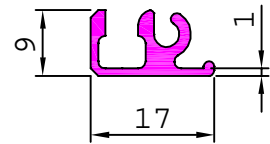
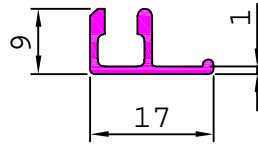
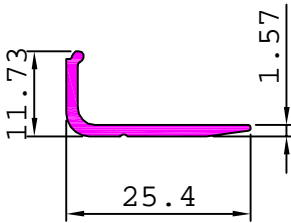

26240

0.339 kg/m

26241

0.633 kg/m

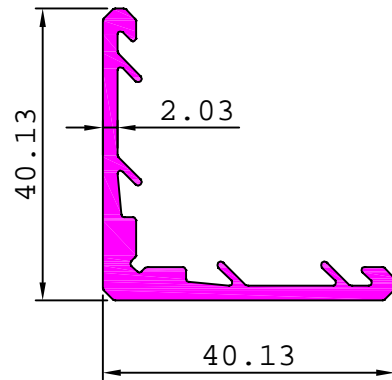
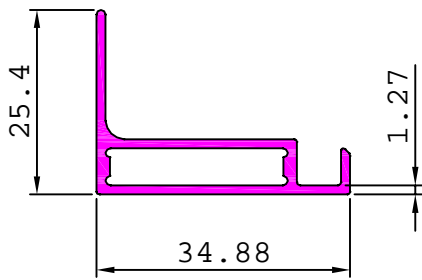

26242

0.605 kg/m

26243

0.716 kg/m

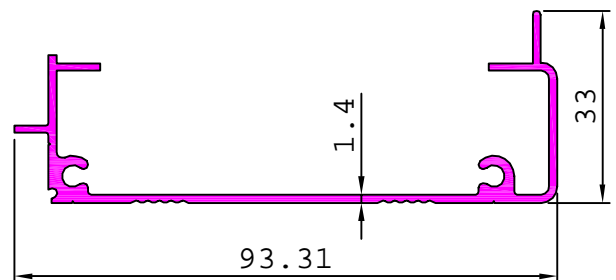
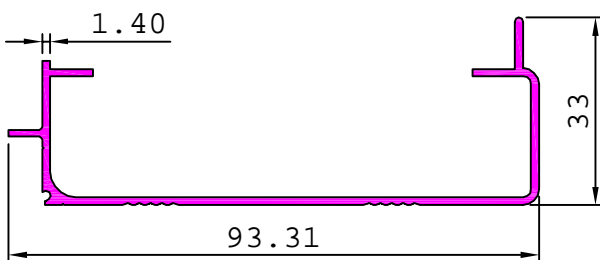

**SOLAR POWER SECTION**

26245

0.780 kg/m

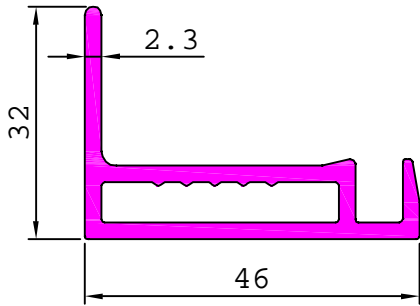

26249

0.531 kg/m

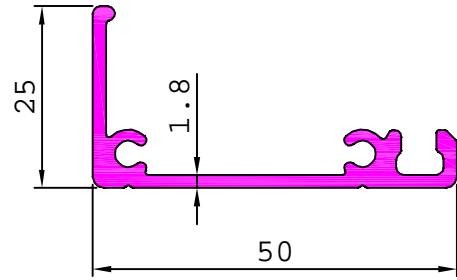

26250

0.315 kg/m

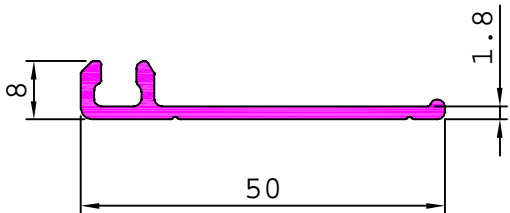

26251

0.483 kg/m

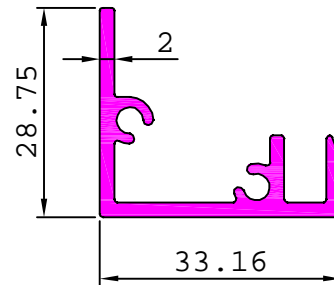

26253

0.627 kg/m

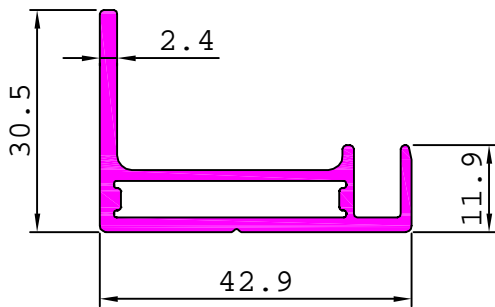

26259

0.374 kg/m

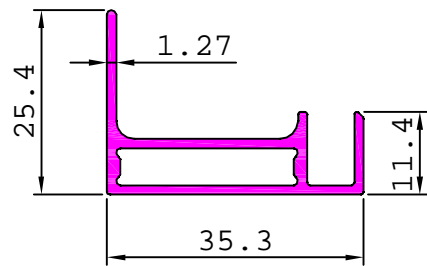

26244

0.198 kg/m

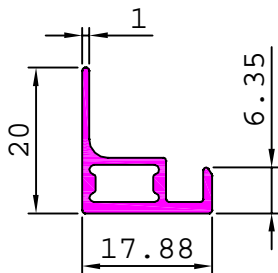

26256

0.256 kg/m

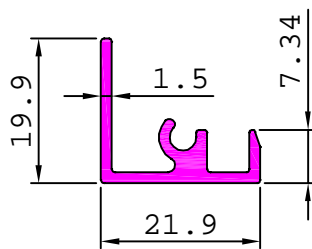

26257

0.133 kg/m

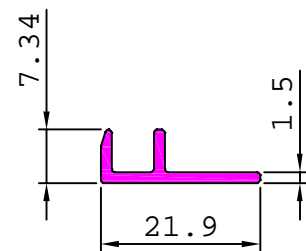

# INDUSTRIAL

## SOLAR POWER SECTION

26258

0.270 kg/m

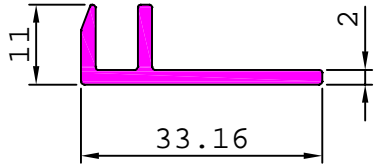

26261

0.113 kg/m

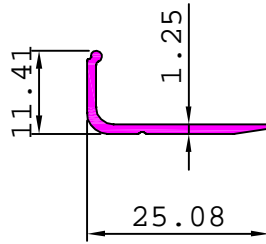

26267

0.173 kg/m

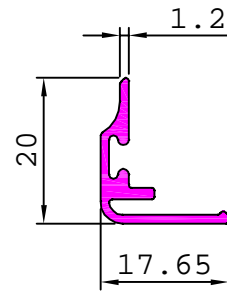

26266

0.372 kg/m

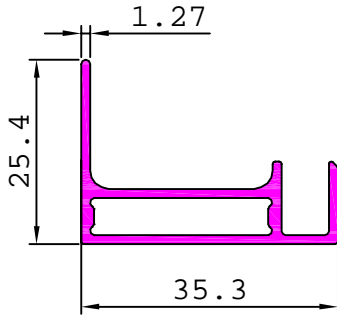

26269

0.631 kg/m

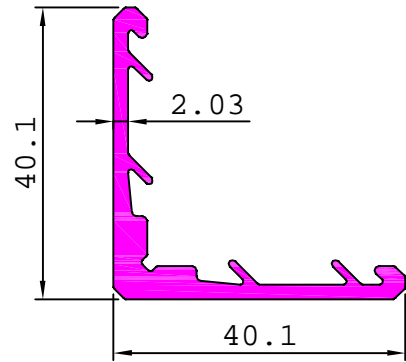

26270

0.378 kg/m

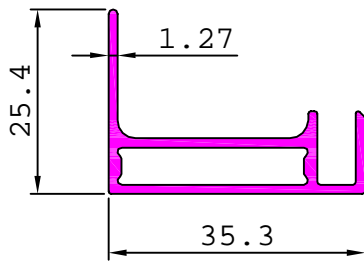

26272

0.344 kg/m

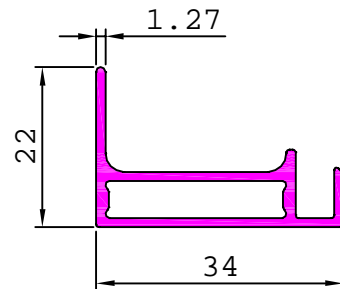

26276

0.680 kg/m

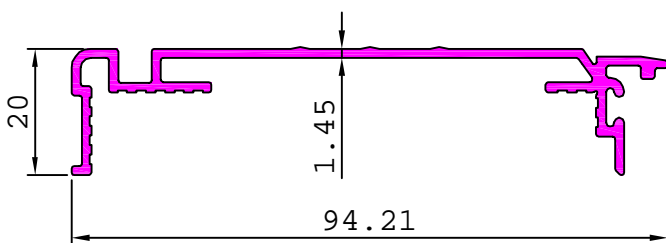

26275

0.525 kg/m

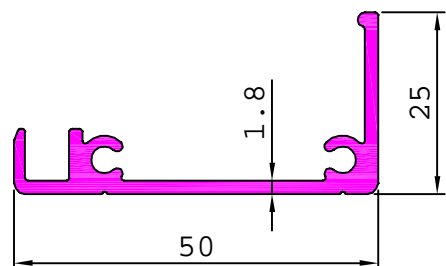

**SOLAR POWER SECTION**

26277

0.308 kg/m

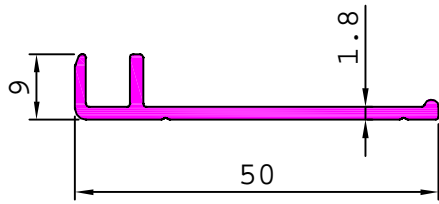

26278

0.355 kg/m

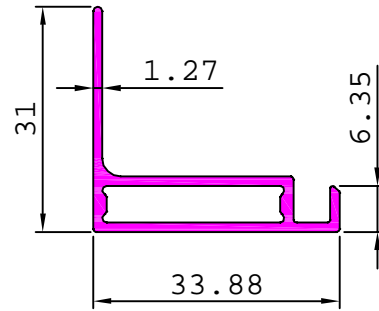

26279

0.721 kg/m

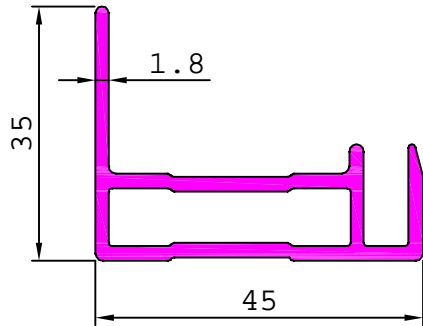

26281

1.055 kg/m

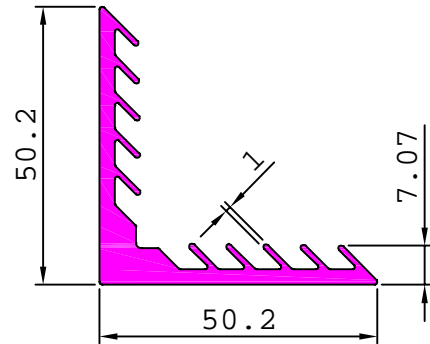

26282

0.571 kg/m

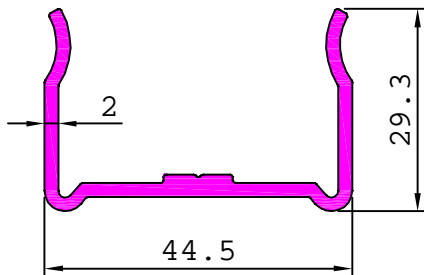

26284

0.614 kg/m

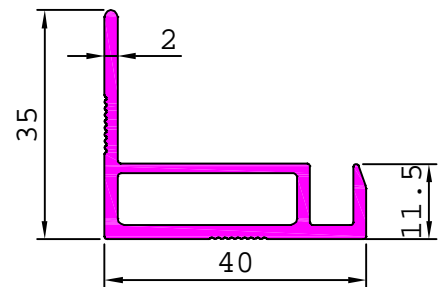

26283

0.862 kg/m

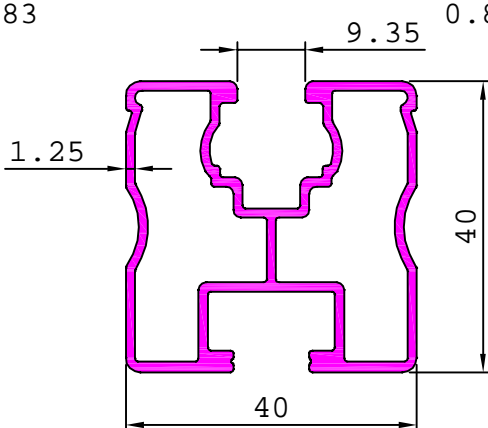

38011

1.176 kg/m

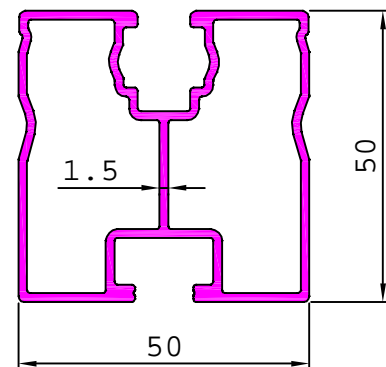

**SOLAR POWER SECTION**

26285

0.648 kg/m

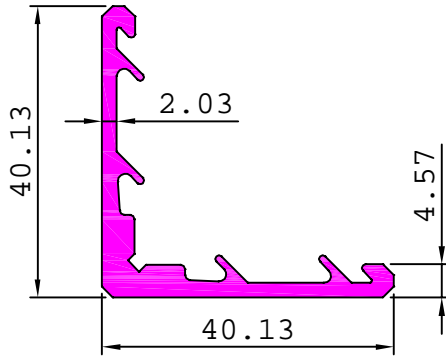

26286

0.741 kg/m

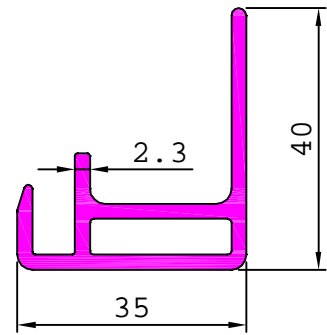

26287

0.273 kg/m

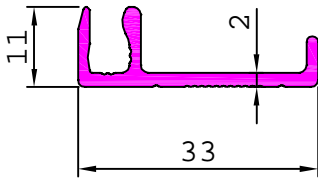

26288

0.419 kg/m

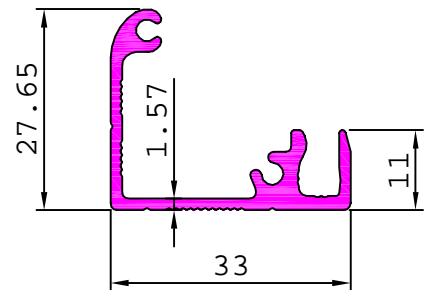

26289

0.595 kg/m

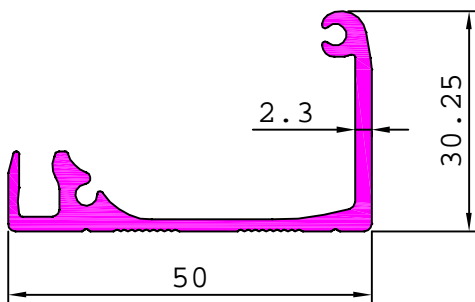

26290

0.599 kg/m

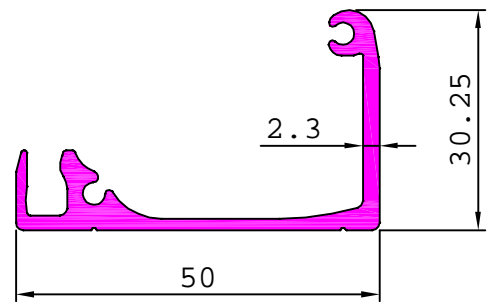

26291

0.454 kg/m

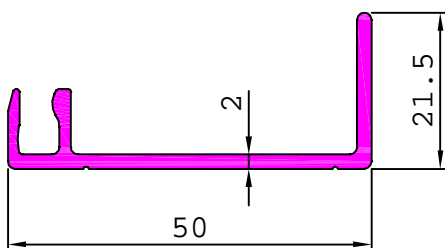

26299

0.343 kg/m

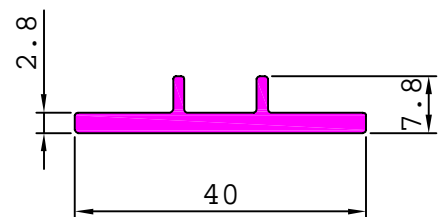

**SOLAR POWER SECTION**

26294

0.380 kg/m

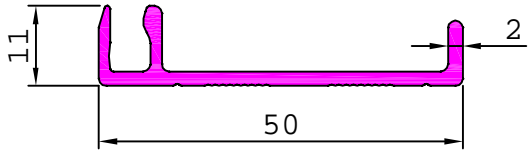

26295

0.419 kg/m

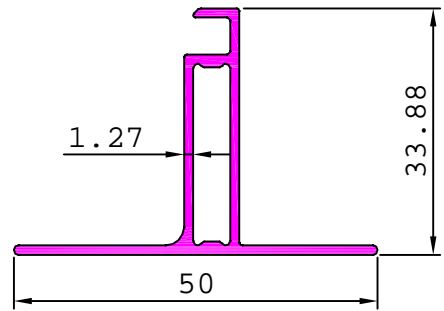

26292

1.028 kg/m

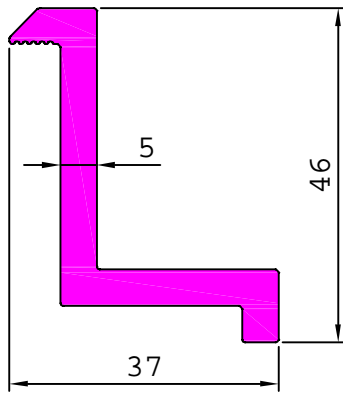

26293

0.933 kg/m

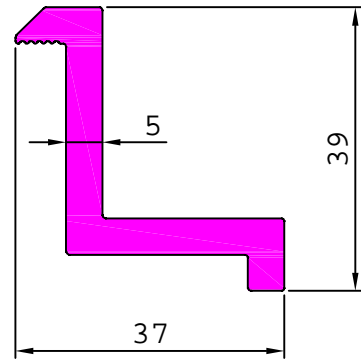

27909

1.365 kg/m

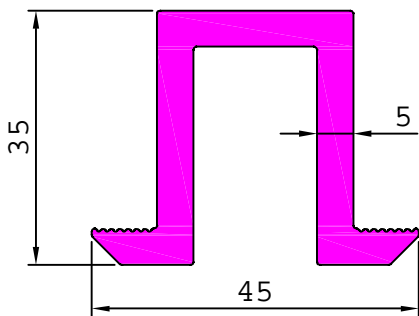

26297

0.642 kg/m

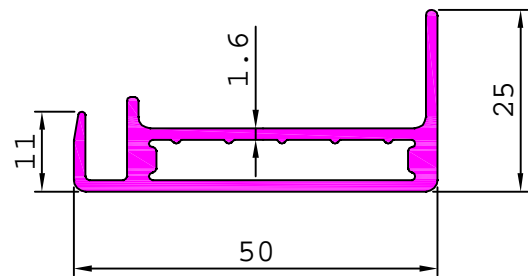

26298

0.520 kg/m

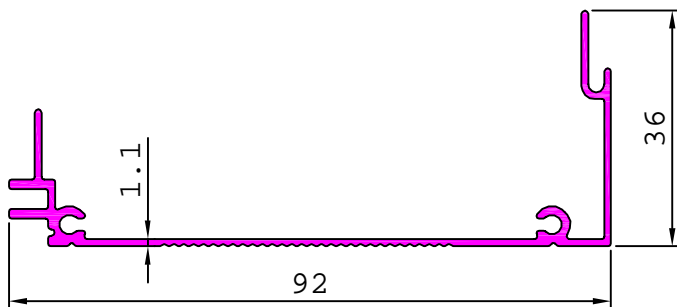

26300

0.475 kg/m

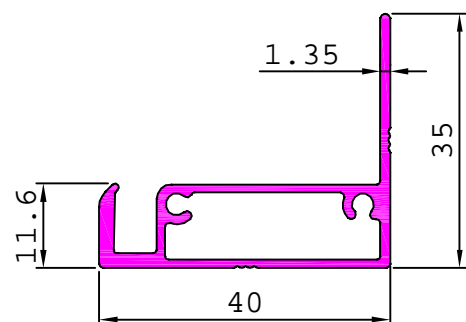

# INDUSTRIAL

## SOLAR POWER SECTION

38001

0.392 kg/m

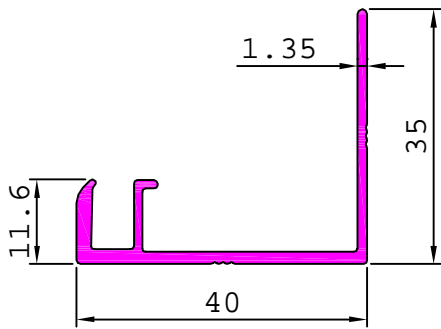

38002

0.837 kg/m

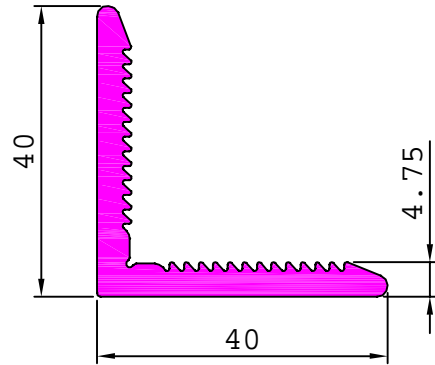

38003

0.636 kg/m

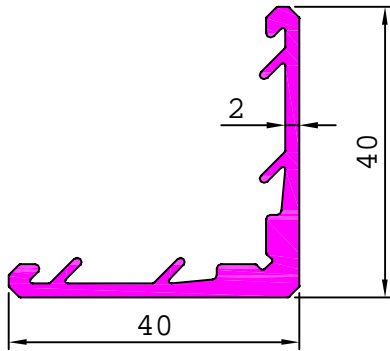

38004

0.546 kg/m

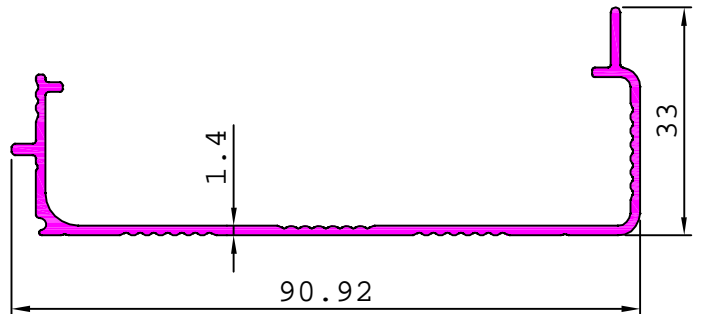

38005

0.650 kg/m

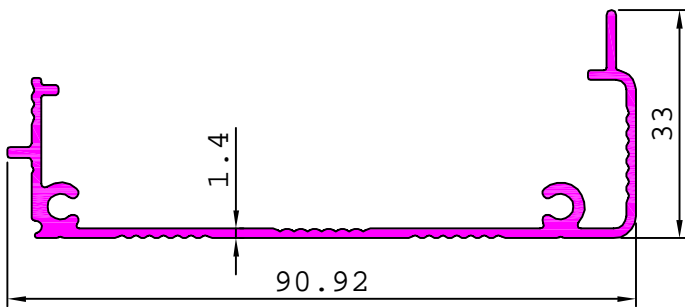

38006

0.473 kg/m

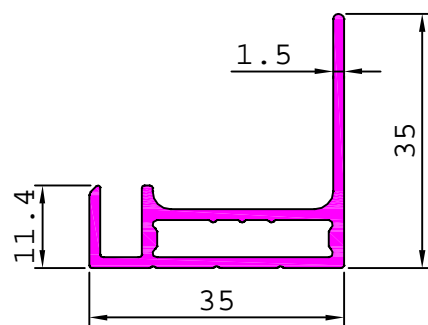

38007

1.201 kg/m

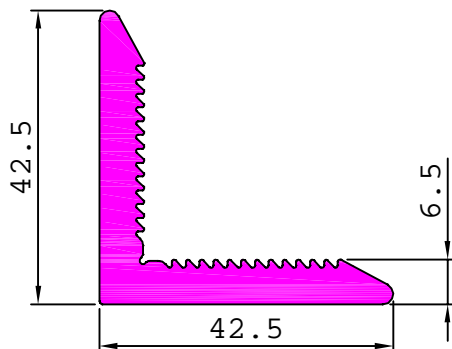

38008

0.954 kg/m

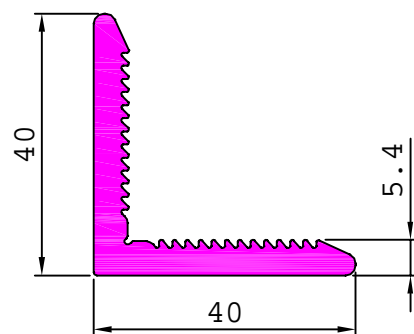



# INDUSTRIAL

## SOLAR POWER SECTION

38009

0.493 kg/m

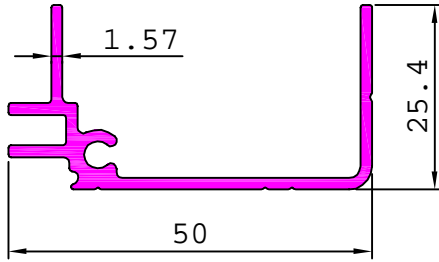

38010

0.660 kg/m

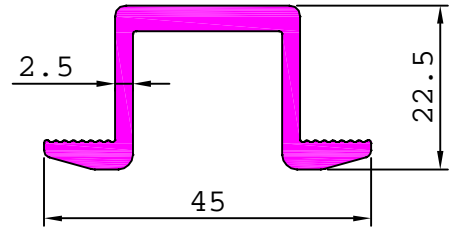

38012

0.402 kg/m

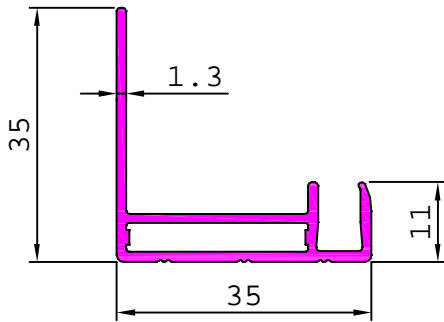

38013

0.374 kg/m

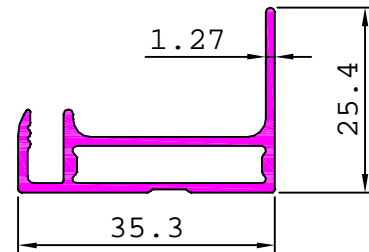

38014

0.339 kg/m

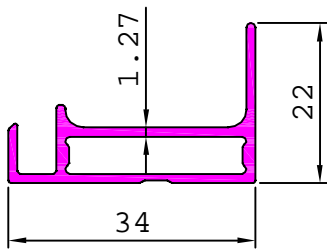

38015

0.359 kg/m

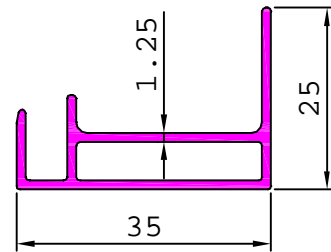

38016

0.719 kg/m

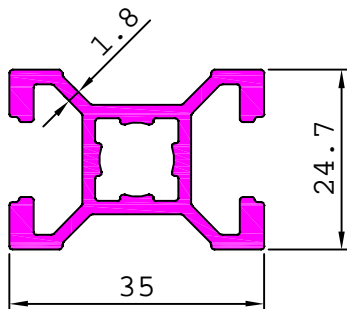

38017

0.251 kg/m

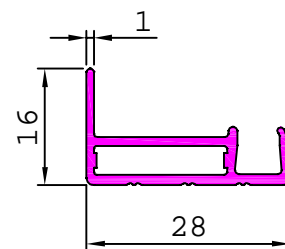

**SOLAR POWER SECTION**

38018

0.280 kg/m

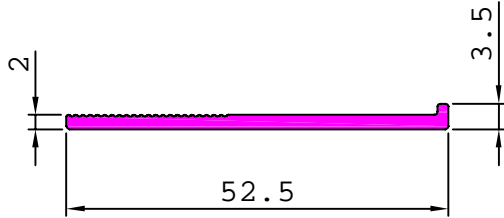

38019

0.782 kg/m

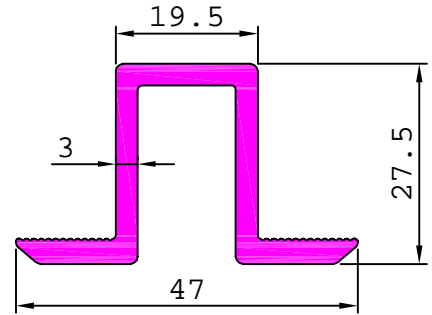

S4507

0.274 kg/m

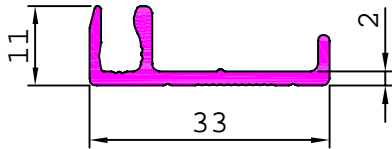

S4508

0.418 kg/m

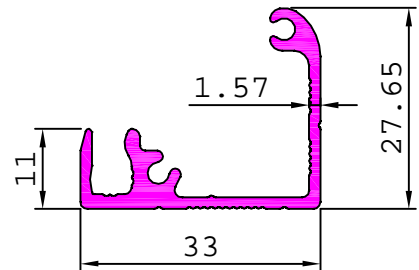

S4509

0.277 kg/m

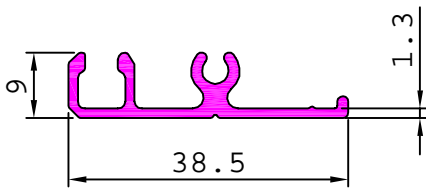

S4510

0.254 kg/m

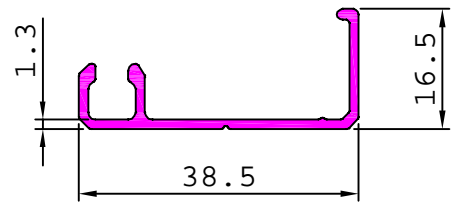

S4335

0.474 kg/m

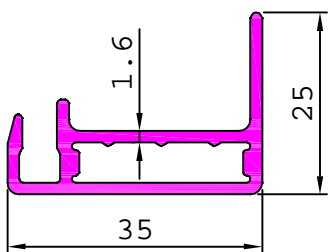

S4483

0.380 kg/m

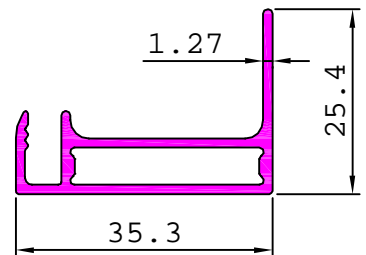

**SOLAR POWER SECTION**

S4923

0.466 kg/m

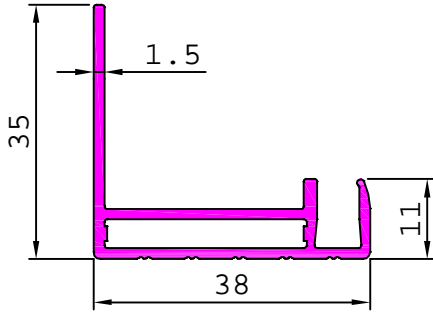

S4924

0.725 kg/m

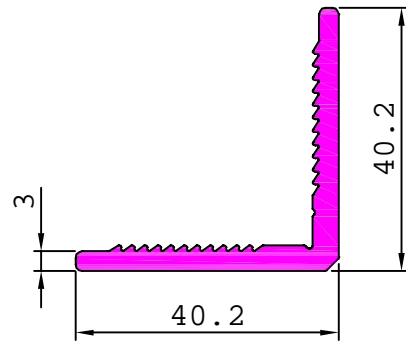

S5899

0.282 kg/m

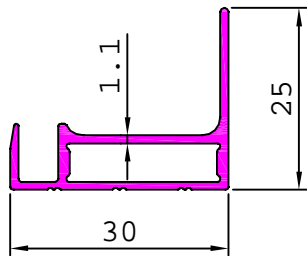

S5984

2.633 kg/m

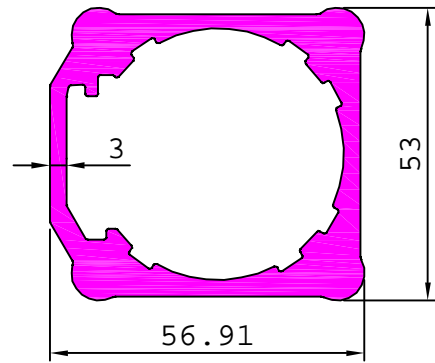

38020

2.398 kg/m

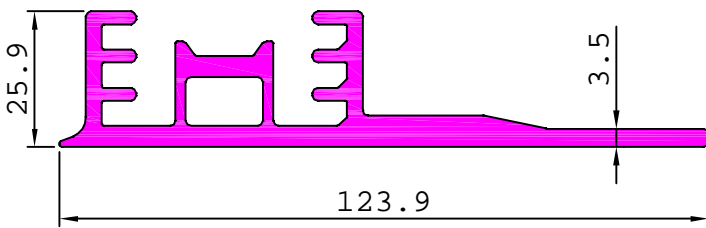

38021

3.715 kg/m

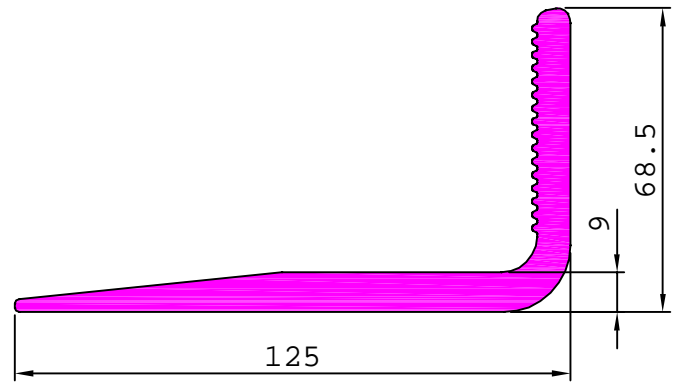

38022

5.590 kg/m

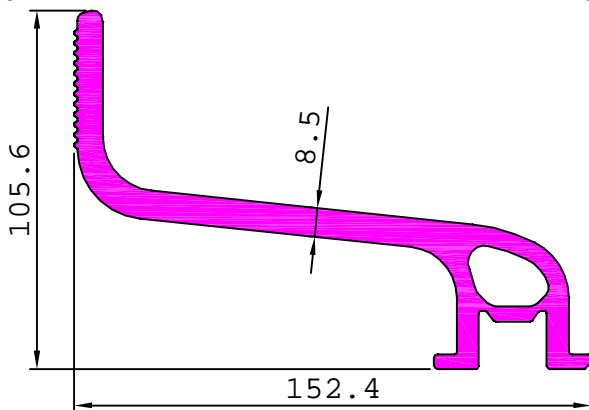

38023

0.922 kg/m

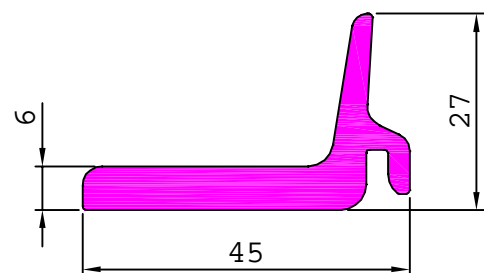

SOLAR POWER SECTION

